

# PRISM™ 2

USER MANUAL



This is the User Manual for the Hollis PRISM 2 Rebreather.

Document #: HO.04.05.0014

This manual, specifications and features of the PRISM 2 are proprietary and copyright Hollis Rebreather, LLC, 2019.

This document may not be copied or distributed without the prior agreement and authorization from Hollis Rebreather, LLC. All information contained is subject to change. Contact the manufacturer for the latest information or go to our website at: [www.hollisrebreathers.com](http://www.hollisrebreathers.com)

Release date 9/20/2019

The PRISM 2 is manufactured in the USA by Hollis Rebreather, LLC.  
1540 North 2200 West, Salt Lake City, UT 84116. USA Ph (877) 598-5796

Hollis Rebreathers Authorized European Market Representative:

Hollis Rebreathers Europe GmbH

T: +49/(0)8061 – 938392 | F: +49/(0)8061 - 938193

Dieselstrasse 2, D-83043, Bad Aibling Germany

[euservice@hollisrebreathers.com](mailto:euservice@hollisrebreathers.com)

EC type examination conducted by SGS United Kingdom Ltd, SGS United Kingdom Limited: 202b, Worle Parkway, Weston-super-Mare, BS22 6WA, United Kingdom. Notified Body 0120.

To ensure your user information is up to date. Please check [www.hollisrebreathers.com](http://www.hollisrebreathers.com) for updates to this manual.

The PPE is subject to the conformity to type based on quality assurance of the production process EU Regulation 2016/425 Module C2 under surveillance of the notified body SGS United Kingdom Ltd, Notified Body No. 0120

To view the Declaration of Conformity, please check: <https://www.hollisrebreathers.com/wp-content/uploads/2019/05/017-HRB-975808-DecConf-B-190920.pdf>

## WARNINGS, CAUTIONS, AND NOTES

Pay attention to the following symbols when they appear throughout this document. They denote important information and tips.



**WARNING:** INDICATES IMPORTANT INFORMATION THAT IF IGNORED MAY LEAD TO INJURY OR DEATH.



**CAUTION:** INDICATES INFORMATION THAT WILL HELP YOU AVOID PRODUCT DAMAGE, FAULTY ASSEMBLY, OR UNSAFE CONDITIONS.



**NOTE:** indicates tips and advice.

## PRISM 2 DESIGN TEAM

Peter Readey  
Bob Hollis  
Robert Landreth  
Art Ferguson  
Chauncey Chapman  
Matthew Addison

## PRISM 2 MANUAL AUTHORS

John Conway  
Matthew Addison

## EDITORS

Jeffrey Bozanic  
Chauncey Chapman  
John Conway  
Gerard Newman

## CONTRIBUTORS

Jeffrey Bozanic  
Gerard Newman  
Dr. Richard Pyle  
Sharon Readey  
Kevin Watts



**HOLLIS**<sup>®</sup>  
**PRISM**<sup>™</sup> 2

Hollis PRISM 2 eCCR  
User Manual

Document Control Number:  
HO.04.05.0014  
Date: 9/20/2019

---

### NOTE:

Information on the operation of the Prism 2 electronics can be found in the Shearwater Petrel User Manual which can be downloaded from <https://www.shearwater.com/support/petrel/>

---

## GENERAL SAFETY STATEMENTS + WARNINGS



### WARNING: USE OF THE PRISM 2 MANUAL

This manual is to be used with the Following Prism 2 Models:

#240-6520-000	PRISM 2 FMCL
#240-6520-000-M	PRISM 2 FMCL METRIC
#240-6530-000	PRISM 2 BMCL
#240-6530-000-M	PRISM 2 BMCL METRIC

Hollis Rebreathers, LLC. makes the declaration the the Prism 2 Models listed above is in conformity with the provisions of EU Regulation 2016/425 and with the Union harmonized standard EN14143:2013. Risks against which the units are intended to protect the user include the following:

1. A loss of the supply of breathing gas – gas contents monitoring
2. Injurious levels of oxygen - properly maintained selected PO<sub>2</sub>
3. Injurious levels of CO<sub>2</sub> in the breathing gas - removal of CO<sub>2</sub> from the breathing gas
4. Unable to return to the surface - buoyancy control and surface flotation

This Manual in conjunction with the Displays and Electronics User Manual can be found at:  
<http://www.hollisrebreathers.com>.

This user manual **does not, nor is it intended to** contain any information needed to safely dive with any type of SCUBA apparatus. It is designed as a guide for the proper setup, operation, maintenance, and field service of the Hollis PRISM 2 CCR only. It does NOT take the place of a recognized training agency instructor-led diver-training course or its associated training manual(s) and materials. This user manual is intended to be used only as a type specific addition to such training and materials, and as a user reference. This manual cannot be used as a substitute guide for any other type of Self Contained Underwater Breathing Apparatus (SCUBA).



### WARNING: GENERAL SAFETY

**No person should breathe from, or attempt to operate in any way, a Hollis PRISM 2 rebreather, or any component part thereof, without first completing an appropriate Hollis Certified user-training course.**

Further, no PRISM 2 diver should use a Hollis PRISM 2 without direct Hollis instructor supervision until they have mastered the proper set-up and operation of the Hollis PRISM 2 rebreather. This includes new PRISM 2 divers as well as PRISM 2 certified divers who have been away from diving for an extended period of time and would benefit from an instructor-led refresher course to regain skills mastery of the Hollis PRISM 2. Failure to do so can lead to serious injury or death.

Your safety while diving the PRISM 2 depends on you knowing your PO<sub>2</sub> (oxygen levels) at all times. This is easily done by monitoring the Heads Up and wrist displays.



### WARNING: CAUSTIC MATERIAL

The CO<sub>2</sub> absorbent used in the scrubber is caustic alkaline material. Take steps to protect yourself from direct lung and skin contact. Furthermore, poor management of the breathing loop could lead to water contact with the CO<sub>2</sub> absorbent, causing a “caustic cocktail” (very caustic liquid). This could lead to severe chemical burns and if inhaled - possible drowning. Proper handling procedures, pre-dive checks, dive techniques, and maintenance mitigates this risk.



### **WARNING: HIGH PRESSURE OXYGEN**

The PRISM 2 uses cylinders, gas feed lines, pressure gauge and other devices which will contain pure oxygen at high pressure when in operation. Oxygen by itself is non-flammable, however it supports combustion. It is highly oxidizing and will react vigorously with combustible materials. Oxygen at elevated pressure will enhance a fire or explosion and generate a large amount of energy in a short time.

The user must maintain all parts of the PRISM 2 that can come into contact with high-pressure oxygen as oxygen-clean components. This includes scheduled servicing by a Hollis service professional, and using approved oxygen-compatible lubricants on any part of the gas delivery systems that will come into contact with high-pressure oxygen.

If any part of the oxygen-clean system comes into contact with contaminants or is accidentally flooded with any substance (including fresh water), you **MUST** have the entire high-pressure oxygen system serviced by an authorized PRISM 2 service professional prior to use. Failure to do so can cause fire or explosion and lead to serious injury or death.



### **WARNING: DESIGN AND TESTING**

The Prism 2 is intended for use on normal recreational and technical diving activities. Although it is capable of sustaining divers operating with high work rates, this is not its intended purpose. At higher work rates the divers needs to take into account a reduced endurance. This is caused by a higher oxygen consumption and a higher CO<sub>2</sub> production, which will reduce the running time of the scrubber material. Additionally, the diver needs to take into account, that a higher work rate can have an impact on the decompression and some additional safety margin should be added to all dive plans. It is the responsible of the diver to inform themselves of the consequences of CNS, OTU's and the effect of decompression.

The Hollis PRISM 2 has been designed and tested, both in materials and function to operate safely and consistently under a wide range of diving environments. You must not alter, add, remove, or re-shape any functional item of the Hollis PRISM 2. Additionally, **NEVER** substitute any part of the Hollis PRISM 2 with third-party items which have not been tested and approved by Hollis for use with the PRISM 2.

This includes, but is not limited to, hoses, breathing assemblies, electronics, breathing gas delivery assemblies and their constituent parts, sealing rings, valves and their constituent parts and sealing surfaces, latches, buoyancy devices, inflation and deflation mechanisms.

Altering, adding, removing, re-shaping or substituting any part of the Hollis PRISM 2 with non-approved parts can adversely alter the breathing, gas delivery or CO<sub>2</sub> absorption characteristics of the Hollis PRISM 2 and may create a very unpredictable and dangerous breathing device, possibly leading to serious injury or death.

Non-approved alterations to functional parts of the PRISM 2 will automatically void all factory warranties, and no repairs or service work will be performed by any Hollis service professional until the altered PRISM 2 unit is brought back into factory specifications by a Hollis service professional at the owner's expense.

The Prism 2 1st stage is not EN250:2014 certified for use with a 2nd stage or BOV. Do not attempt to connect an alternate breathing supply to this first stage.



### **WARNING: BMCL HEADS DOWN POSITION**

There is a significant risk of excessive gas loss from the BMCL overpressure valve (OPV) in a vertical heads down position (-45 and -90 degree positions) during the dive. Extra monitoring of onboard breathing gas and cylinder contents should take place if you are forced into this position during the dive, however it is not recommended to dive in a vertical position at any time.



### **WARNING: COMPUTER / CONTROLLER-SPECIFIC WARNINGS**

This computer is capable of calculating deco stop requirements. These calculations are predictions of physiological decompression requirements. Dives requiring staged decompression are substantially more risky than dives that stay well within no-stop limits.

**Diving with rebreathers and/or diving mixed gases and/or performing staged decompression dives and/or diving in overhead environments greatly increases the risks associated with scuba diving.**



### **WARNING: COMPUTER SOFTWARE**

Never risk your life on only one source of information. Use a second computer or tables. If you choose to make riskier dives, obtain the proper training and work up to them slowly to gain experience. Always have a plan on how to handle failures. Automatic systems are no substitute for knowledge and training. No technology will keep you alive. Knowledge, skill, and practiced procedures are your best defense.



### **WARNING: WEIGHTING OF THE HOLLIS PRISM 2**

Unlike open circuit scuba gear, it is possible for the Hollis PRISM 2 breathing loop to flood, causing the rebreather to quickly become 17 pounds/7.7 kg negatively buoyant (not including any user-added weight or offsetting buoyancy inflation). It is the responsibility of the diver to insure that the Hollis PRISM 2 is never weighted in such a way that it is not possible for the installed buoyancy device to overcome the flooded weight of the unit plus any diver-added non-detachable weights, and still provide enough positive buoyancy at the surface to keep the divers head well above water.

Consult your instructor, dealer, or call the Hollis factory directly with any questions or concerns. Failure to maintain positive buoyancy at the surface with the Hollis PRISM 2 in a fully flooded state can lead to serious injury or death.



### **WARNING: BREATHING GAS**

The Prism 2 carries two cylinders on board. One contains oxygen and the other a diluent. Oxygen is fed into the breathing circuit via a solenoid operated oxygen valve; the diluent is fed in manually and automatically if the Automatic Diluent Valve (ADV) is fitted. The oxygen is added to replace metabolized oxygen and to maintain the oxygen pressure during ascents and is an automatic process. The purpose of the diluent is to dilute the oxygen concentration to enable us to safely breathe the mixture in the breathing circuit (or loop) below 6m and also maintain the counterlung volume during the descent. Once at depth the diluent is no longer used unless there is a loss of loop volume. Diluent also provides gas for BC inflation, suit inflation, oxygen cell checks and open circuit bailout. The correct type of diluent is essential and should be breathable throughout the entire dive. For normal diving, the diluent should be air for all depths down to your air diving limit (35 to 40m). Using a setpoint of 1.3, 40m is the maximum depth with an air diluent. Below 40m, Trimix (with a max. EAD of 24m to a depth of 100m) should be used.



### **WARNING: BAILOUT GAS**

The diver must always carry bailout gas, that provides an adequate volume and safe breathing mix, to deliver the diver safely to the surface from all points during the dive. Divers can and do die from underestimating their bailout needs. The diver shall receive details, training, and materials on selecting appropriate gases, volumes, and bailout equipment from their selected Hollis approved training agency and instructor.



### **WARNING: USER-PACKED RADIAL SCRUBBER**

As of this writing, the Hollis PRISM 2 design does not include any technology or other device which can detect or warn of potentially dangerous levels of carbon dioxide (CO<sub>2</sub>) within the breathing loop.

The Hollis PRISM 2 utilizes a user-packed, radial design CO<sub>2</sub> scrubber. Only Hollis tested and approved CO<sub>2</sub> adsorbents should be used, and factory-stated maximum scrubber durations must NEVER be exceeded. Exceeding factory stated scrubber durations for a tested material will eventually lead to serious injury or death.

It is entirely possible that, for any number of reasons including but not limited to: channeling, ambient temperature, exhausted, damaged, inappropriately stored, or (for whatever reason), inert scrubber material, the chemical and thermodynamic reaction required to sequester gaseous CO<sub>2</sub> will not occur as expected, and a toxic, and possibly fatal level of gaseous CO<sub>2</sub> within the breathing loop can result.

You must carefully follow all instructor and manufacturer recommendations for use and handling of CO<sub>2</sub> absorbent, never use a CO<sub>2</sub> absorbent if you cannot verify that it is able to sustain CO<sub>2</sub> absorption and carefully pack the radial scrubber and complete a system pre-breathe prior to each immersion, as you were taught in your training course.

Further, you must carefully monitor yourself for any symptoms of possible CO<sub>2</sub> poisoning whenever you are breathing from the Hollis PRISM 2, and bail-out to open circuit should any physical or mental symptom lead you to suspect elevated CO<sub>2</sub> levels in your breathing loop. Failure to bailout at the first sign of trouble can lead to serious injury or death.



### **WARNING: NAUSEA AND THE BREATHING LOOP**

The introduction of biological solids into the DSV can lead to obstruction of the critical mushroom valves causing a situation whereby fresh gas is not being circulated to the diver and consequently, a buildup of CO<sub>2</sub> in the diver. Additionally, nausea is a known symptom of improper gas mixture and/or contamination. During operation of the Prism 2, should you begin to feel the onset of nausea, immediately switch to an appropriate open circuit bailout as soon as you can perform the task safely, and abort the dive. Consult your PRISM 2 instructor for further details/training.



### WARNING: PROPER BATTERIES

**ONLY** name-brand batteries (such as “Duracell” or “Eveready”) may be used to power the PRISM 2. Off-brand or Discount batteries have been found to vary greatly in quality of materials from batch to batch (and even piece to piece!) Therefore they may not perform as expected, or be capable of consistently delivering the power required to drive the Prism 2 components, despite battery voltage levels reported by a battery voltage meter.

**While off-brand / discount batteries are perfectly acceptable for use in toys and flashlights, they have no place in life support gear and must never be used to power any component of your PRISM 2.**

**Because of the potential rapid drop-off of charge from rechargeable batteries, rechargeable batteries are not recommended for use with your PRISM 2 rebreather and must not be used.**

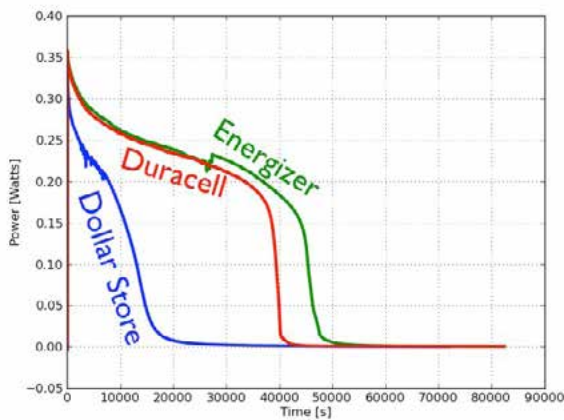

Diagram showing rapid discharge of non-branded batteries that in life support gear can result in unnecessary hazards.

The full article, “Are Expensive Batteries Worth The Extra Cost?” is available at [Wired.com](http://Wired.com)

Image courtesy of Rhett Allain, Wired



### WARNING: OPERATIONAL RANGE

The PRISM 2 has been tested and qualified for use in water depths of up to 328 ft (100 m) and water temperatures between 39° - 93° F (4° - 34° C).





## **WARNING: COLD WATER**

Diving rebreathers in frigid water requires special equipment, training, and preparation to prevent possible injury or death. Closed Circuit Rebreathers present unique variables to cold water diving that are not a factor in open circuit diving in the same temperatures. Cold water diving is beyond the scope of this manual. There are many variables not listed here. It is essential and the responsibility of the diver to be aware of all issues. The diver must know how to best prepare their equipment, and how to best prepare themselves for the cold water environment. The diver must obtain further training beyond standard CCR training or Open Circuit Ice Diver certification alone.

Cold Water Issues Include The Following:

- Alkaline battery performance degrades as the temperatures decrease. If diving consistently in waters approaching freezing, it is recommended to use lithium batteries.
- Changes in temperature may lead to expansion and contraction of CO<sub>2</sub> absorbent material possibly leading to channeling or damage to the absorbent itself. Further, allowing the moisture in the absorbent to freeze will mean that CO<sub>2</sub> adsorption may not occur.
- Decreases in temperature effect the efficiency of the scrubber considerably.
- Sensors are sensitive to extreme temperatures. Storage of Oxygen Sensors below 32° F (0° C) or above 100° F (37.8° C) can damage or greatly shorten the life of the sensor.
- Mushroom valves may freeze open or closed if condensation is allowed to cool. Always perform mushroom valve (stereo valve) checks and pre-breathe the unit before entering the water and before any subsequent dives. The diver should warm and visually inspect the mushroom valves between dives.
- Use of the manual addition valves should be limited to short bursts of less than 1 or 2 seconds at a time. Prolonged valve activation may cause freezing of the mechanism in frigid waters due to adiabatic cooling.



## **Training Standards:**

Hollis Rebreathers recommends rebreather training from a recognized training agency that meets or exceeds the minimum standards set by the Rebreather Education Safety Association (RESA).

# TABLE OF CONTENTS

General Safety Statements & Warnings

iii-viii

## PART 1 SYSTEM OVERVIEW

### SECTION 1

DESIGN PHILOSOPHY

### SECTION 2

SCHEMATICS + DESIGN

**ARTICLE: TAKING CARE OF YOUR  
OXYGEN SENSORS**

**ARTICLE: THE SOLENOID AND  
THE PID CONTROLLER**

### SECTION 3

FITTING YOUR PRISM 2

**ARTICLE: STABILITY**

## PART 2 SETUP

### SECTION 1

AN O-RING CLEANING PRIMER

### SECTION 2

PACKING THE PRISM 2 CO<sub>2</sub> SCRUBBER

### SECTION 3

USING CHECKLISTS

### SECTION 4

COMPONENT INSPECTION CHECKLIST

### SECTION 5

ASSEMBLY ORDER CHECKLIST

### SECTION 6

PRISM 2 OPERATIONAL CHECKLIST

### SECTION 7

POST DIVE CHECKLIST

### SECTION 8

MAINTENANCE + REPAIR LOG

## PART 3

**ARTICLE: MINIMUM, MAXIMUM AND  
OPTIMAL LOOP VOLUMES AND WORK OF  
BREATHING**

## PART 4

### MAINTENANCE + CLEANING

#### SECTION 1

SERVICE FACILITY & YOU

#### SECTION 2

ROUTINE CLEANING

## PART 5

### APPROVED PRODUCTS, CAPACITIES, & SPECS

#### SECTION 1

LIST OF APPROVED PRODUCTS  
FOR USE IN YOUR PRISM 2

#### SECTION 2

COMPONENT CAPACITIES + SPECS

#### SECTION 3

GLOSSARY

#### SECTION 4

NOTES



**REBREATHERS CAN KILL YOU!**

**PROPER TRAINING, FOLLOWING YOUR TRAINING, NOT EXCEEDING THE LIMITS OF YOUR TRAINING, AND STAYING CURRENT WITH YOUR TRAINING ARE ALL PREREQUISITES FOR A SAFE REBREATHER DIVING CAREER, NO MATTER WHICH REBREATHER YOU ARE USING.**

**READ THE MANUAL.**

**STAYING CURRENT ON REBREATHER X DOES NOT MEAN YOU ARE CURRENT ON REBREATHER Y. THAT IS WHY WE WRITE THESE MANUALS. TAKE A PAUSE AND REREAD THE MANUAL IF IT HAS BEEN A WHILE SINCE YOU HAVE BEEN DIVING YOUR PRISM 2. IT CAN MAKE ALL THE DIFFERENCE BETWEEN A GREAT OR TERRIFYING**

**DIVE.**

**DONT BE CHEAP.**

**LASTLY, REMEMBER DON'T BE CHEAP! DON'T BE CHEAP WITH YOUR CONSUMABLES SUCH AS ABSORBENT, O<sub>2</sub> SENSORS, ANNUAL SERVICES, AFTERDIVE SANITIZING REGIMIN AND MOSTLY, DONT BE CHEAP WITH YOUR TIME IN CAREFUL SETUP, PRE-DIVE AND IN-WATER CHECKS.**

## SYSTEM OVERVIEW DESIGN PHILOSOPHY

**The PRISM family of rebreathers has a long and illustrious history, and it is considered one of the foundation platforms of the modern day electronically controlled “sport” rebreather.**

**The PRISM 2, like its predecessor the PRISM Topaz, is a digitally controlled electronic closed circuit rebreather with split Front-Mounted Counterlungs (FMCL) or Back-Mounted Counterlungs (BMCL). It incorporates a radial design scrubber for the best possible duration and work-of-breathing. All gas delivery systems on the PRISM 2 have both automatic and manual function.**

### MANUAL CONTROL OR COMPUTER CONTROL?

One of the ongoing debates when discussing rebreather safety is whether manually controlled or electronically controlled rebreathers are safer. From the day in 1995 when PRISM Topaz class #1 was held in Hermosa Beach, CA, students were taught to “fly” their rebreathers manually by watching their secondary analog displays and manually injecting oxygen and diluent as needed.

From day one, PRISM students were taught that the primary control system was always the divers brain. It wasn’t until the last dive of the last day of class that students were told, “OK, you can turn on your electronics and experience a computer controlled dive”.

Diving with the computer monitoring the oxygen and the user keeping an eye on everything with (at that time) a Heads Up Display primary and a wrist-mounted analog secondary sure kept us busy, but we quickly realized that the computer was a LOT better at closely maintaining a setpoint! We also realized that our instructor had trained us to be manually controlled rebreather divers with the safety of “computer over-watch”.

Why two independent monitoring systems in one rebreather? Simply put, electronics, batteries and wiring combined with salt water (or even fresh water) do not get along well together. While we can seal circuit boards and wiring interfaces against water intrusion, rebreathers should have a diver accessible compartment to change batteries, and because of this need for accessibility, flooding can occur.

This is the Achilles heel of rebreathers with on-board electronics. Any time an O-ring sealed Compartment is unsealed, the potential for debris to get on the O-ring and cause the compartment to flood during the next dive is increased.

So, with two separate systems onboard with separate battery compartments, if one battery compartment floods and destroys the battery, we simply switch to the other monitoring system to safely end the dive. When our dive is over, we dispose of the wiring harness and battery, clean the compartment and put in a fresh battery and new O-ring(s).

## SCHEMATICS + DESIGN THE GAS PATH

The PRISM 2 incorporates either a Front Mounted split counterlung design or a Back Mounted counterlung design. The gas flows through the loop from left to right shoulder in both designs, which has become a standard in the recreational rebreather market. Figure 1.1a shows the Front-Mounted Counterlung design.



Fig. 1.1

## OXYGEN & THE EXHALATION SIDE OF THE LOOP

Pure oxygen injection into the system, whether manually or electronically, via the solenoid, is injected into the exhalation side of the breathing loop. This design insures that a diver can never inadvertently get a high partial pressure dose of oxygen while diving, and that oxygen which is injected into the loop has plenty of time to properly mix with the loop gas, thereby avoiding potentially dangerous O<sub>2</sub> spikes.

## HEAD PLATE + RED CO<sub>2</sub> SEAL

Once the diver-exhaled gas enters the head, it travels into the head plate, which is also where O<sub>2</sub> injected by the solenoid enters the breathing loop. The red CO<sub>2</sub> seal (Fig. 1.2) which seals the scrubber basket to the head plate sits in a groove at the end of the head plate facing the scrubber basket. The Red CO<sub>2</sub> seal must be in place at all times during diving operations!



**WARNING: BREATHING FROM THE PRISM 2 WITHOUT THE RED CO<sub>2</sub> SEAL IN PLACE WILL RESULT IN 100% GAS BYPASS OF THE SCRUBBER. FAILURE TO INSURE THAT THE RED CO<sub>2</sub> SEAL IS PROPERLY INSTALLED MAY LEAD TO INJURY OR DEATH.**



Fig. 1.2

## THE SCRUBBER BASKET

The gas leaves the head plate and enters the radial scrubber basket through its center tube (Fig. 1.3). As the gas radiates outwards through the CO<sub>2</sub> absorbent and towards the bucket walls, exhaled CO<sub>2</sub> is chemically sequestered (adsorbed) by the CO<sub>2</sub> absorbent, and any added oxygen is mixed with the loop gas as it travels through the scrubber granules. Upon exiting the scrubber, the heated gas enters the thermal air jacket area between the basket and bucket.

The air jacket serves two purposes: First and most important, it insulates the scrubber material from colder external temperatures, which helps increase the efficiency of the absorption process. Secondly, the moisture in the heated gas exiting the scrubber has an opportunity to condense along the cooler bucket wall, dropping the overall humidity of the gas entering the oxygen sensor housing.

From the thermal jacket, the gas flows up through the scrubber basket flow vanes (Fig. 1.4). This restriction creates higher gas velocities in the sensor area without increasing work of breathing, further dropping the dew point of the gas as it reaches the oxygen sensors. By using natural condensation along the surface of the bucket wall and manipulating gas velocities in the area around the O<sub>2</sub> sensors, we are able to keep the sensors as dry as possible without adding complexities such as sponges or other moisture blocking devices.



Fig. 1.3



Fig. 1.4

## THE COUNTERLUNGS: FRONT MOUNTED (FMCL)

### THE INHALATION COUNTERLUNG

The inhalation counterlung is a 3.5 L or optional 2.5 L (currently available in the USA market only) front-mounted split counterlung design (*Fig. 1.5*) made of rugged nylon with a food-grade urethane interior. It houses the automatic diluent addition valve (ADV), counterlung drain, hose mounting hardware and BCD inflation hose wrap at its front.

The hose attaching hardware for both the head and DSV assembly attaching points (*Fig. 1.6*) are welded into place, so they cannot become loose and cause an unintended loop flood. The DSV hose attaching hardware is “keyed” (*Fig. 1.7*) and will only accept the corresponding hose assembly elbow, thereby avoiding incorrect assembly of the loop which would result in potential reversal of gas flow within the loop. The Inhalation Counterlung has a 6-sided key, the Exhalation Counterlung has a 4-sided key.

Behind each counterlung, under the Fastex Buckle panel are weight pockets (*Fig. 1.8*) which will accept up to 5 lbs/2.3 kg of hard or soft weight. The weight pouch flap is held in place with Velcro. There are 2 D-rings on the counterlung, one on the side and one at the bottom. Each counterlung has a water drain at its bottom (*Fig. 1.9*) to drain fluids as they accumulate during a dive. The Fastex clip panel on the back of the counterlung contains 2 Fastex clips for clipping the counterlungs to the harness, backplate, and one chest strap with Fastex clips.

### ADV (AUTOMATIC/MANUAL DILUENT ADDITION VALVE)

Having the ADV (*Fig. 1.10*) on the inhalation side of the loop makes sense for several reasons. Should the oxygen content ever become dangerously low, dangerously high, or the diver begins feeling “abnormal”, a known normoxic gas is immediately available while still breathing from the loop prior to switching to bailout\*. Therefore, having the diluent as close to the mouthpiece as possible is the best way to insure that fresh breathing gas of known and safe oxygen content is only a breath away. \*(Not applicable if the diluent is a hypoxic mix)

The ADV is held in place by a threaded fitting welded to the counterlung. To remove the valve for servicing, unscrew the outside retaining nut by turning it counter- clockwise until the valve comes loose. There is a rubber gasket under the valve which seals the valve body to the counterlung fitting. The removable plunger activates a Schrader valve which allows the gas to flow into the loop. The counterlung fitting is keyed so the valve will not rotate while in use. While the valve is shipped from the factory with the QD fitting facing up, the valve will work in any rotation.



Fig. 1.5



Fig. 1.6



Fig. 1.7



Fig. 1.8



Fig. 1.9



Fig. 1.10

DSV hose



DSV Inhalation side fitting

You will notice that the mounting hardware for the DSV also holds the inhalation mushroom valve.

## THE EXHALATION SIDE COUNTERLUNG

The Exhalation side counterlung is of similar build and size to the Inhalation side counterlung in all respects excepting it houses the manual oxygen addition valve and the automatic, adjustable loop over-pressure valve (OPV). (*Fig. 1.11*)



Fig. 1.11

## BREATHING HOSES + HARDWARE

The Breathing hoses (*Fig. 1.12*) are 15" X 1 1/2" fixed-length rubber breathing hoses. They can not be cut to a different length. The Inhalation hose hardware which connects the hose to the DSV and counterlungs, also houses the inhalation mushroom valve on the DSV side of the hose. All mounting hardware is held in place by two Oetiker clamps on each side of each hose.



Fig. 1.12



## OPV (OVER PRESSURE VALVE)

The OPV (*Fig. 1.13*) is an automatic or manual adjustable pressure relief valve which is screwed into a fitting welded onto the front of the exhalation counter-lung. To adjust the release pressure of the ADV, simply turn the body of the valve clockwise to increase the cracking pressure and counter-clockwise to decrease cracking pressure. To operate the valve manually, simply depress the body of the valve. The OPV is not a serviceable part so should it ever fail, it must be replaced.



Fig. 1.13

## MANUAL OXYGEN ADDITION VALVE

The manual oxygen addition valve (*Fig. 1.14*) is located on the inside of the exhalation counterlung. It is a push button valve operated by a schrader valve. Under the quick disconnect fitting is a 0.0020 inch/ 0.051 mm flow restrictor, to meter the injection of oxygen into the Loop. The manual oxygen valve is held in place by a threaded fitting welded to the counterlung. To remove the valve for servicing, unscrew the outside retaining nut by turning it counter-clockwise until the valve comes loose. There is a rubber gasket under the valve which seals the valve body to the counterlung fitting. The counterlung fitting is keyed so the valve will not rotate while in use. While the valve is shipped from the factory with the QD fitting facing up, the valve will work in any rotation.



Fig. 1.14

## DSV (DIVE SURFACE VALVE)

The Dive Surface Valve (*Fig. 1.15*) is a neutrally buoyant one-way loop “shut down” valve with a water purge. The rotating barrel is made of stainless steel. The exhalation mushroom valve is seated on the right side of the valve housing. The DSV can be used with the Front-Mounted or Back-Mounted Counterlungs.



Fig. 1.15

## MOUTHPIECE RETAINING SYSTEM

A mouthpiece retaining strap is included with the Prism 2 Rebreather. This part minimizes the ingress of water during normal use and ensures the mouthpiece is held in place and the diver remains on the loop in the event of a diver falling unconscious or having a convulsion. This mouthpiece retaining system design has a long history of use by AP Valves / Silent Diving.



Fig. 1.16

To install the mouthpiece retaining system on the Prism 2 DSV mouthpiece, the adjustment straps should be fixed to the each end of mouthpiece barrel using the orings installed. Once installed on the mouthpiece, this should be left attached and the hose ends will attach as normal. (Fig 1.16)

To don the retaining strap, loosen the silicone straps by depressing the release button on the back. Fit over the top of the head and tighten around the head or neck, depending on preference (Fig 1.16.1). To tighten the retaining strap, pull the silicone tabs on the left and right side to fit the desired size. To doff, depress the release button to loosen the silicone straps and remove.



Fig. 1.16.1

## THE COUNTERLUNGS: BACK MOUNTED (BMCL)

The back-mounted counterlungs offer low hydrostatic pressures in the most common positions and provides a clear chest area. The reduced volume of the rear mounted counterlungs makes it easier to maintain minimum loop volume and makes it easier to maintain horizontal body trim.



Fig. 1.17

## THE INHALATION COUNTERLUNG

The Back-Mounted Counterlungs comprise of two 3.5 L back -mounted split counterlungs consisting of a food-grade urethane interior counterlung encased in a rugged nylon exterior (Fig. 1.17). The T-Piece at the top of the Inhalation counterlung houses the automatic diluent addition valve (ADV) and a manual diluent addition is plumbed in line with the ADV supply hose. The ADV is fitted with the diaphragm facing away from the inhalation counterlung and supplies gas to the loop whenever a deep inhalation (negative pressure) is applied to the inhalation counterlung. This activates a tilt valve mechanism to allow gas to enter the loop from the diluent cylinder. This “Tilt Valve” design reduces the unwanted addition of diluent as gas shifts around the system during normal diver movement. There is no drain valve on the inhalation counterlung.



Fig. 1.18

The hose attaching hardware for both the head and DSV assembly attaching points (Fig. 1.18) are attached to the T-Piece. The T-Piece is screwed into the Inhalation Counterlung fitting. The Urethane Counterlung threaded fitting is screwed into the urethane counterlung opening at the top of the counterlung.



Fig. 1.19

### Attaching a DSV

The inhalation side DSV attaching hardware houses the inhalation mushroom valve and DSV counterweight in the plastic holder (Fig. 1.19). The exhalation side attaching hardware is an open plastic fitting which also holds the DSV counterweight in place. The Inhalation side of the DSV contains a channel cut across the threads of the DSV housing. If a user were to accidentally install the DSV reversed, this channel creates a bypass that will insure the assembled unit would not pass a positive or negative test. Also, with both the inhalation and exhalation mushroom valves butted up against each other in such a configuration, would insure that a user could neither inhale OR exhale into the assembled rebreather through the incorrectly placed DSV.



Fig. 1.20

### Attaching the Back Mounted Counter Lungs (BMCL)

Behind the inhalation counterlung are Velcro straps to hold the BMCL snugly onto the backplate harness (Fig. 1.20). Secure the BMCL to the Diver harness by wrapping the straps around the shoulders of the harness and securing the straps so they are securely fastened and are aligned. Sandwich the middle portion of the strap between the two other straps. It is essential to keep the counterlungs against your back and upper rear shoulder to avoid excessive hydrostatic imbalance and maintain the proper breathing characteristics.

## THE EXHALATION SIDE COUNTERLUNG

The exhalation counterlung (*Fig. 1.21*) is similar in most respects to the inhalation counterlung. It too is a 3.5 L back-mounted split counterlung design consisting of a food-grade urethane interior counterlung encased in a rugged nylon exterior. The T-Piece at the top of the exhalation counterlung houses the manual oxygen addition port. There is a manually activated drain valve on the bottom rear of the exhalation counterlung.

The hose attaching hardware for both the head and DSV assembly attaching points are attached to the T-Piece. The T-Piece is screwed into the exhalation counterlung fitting (*Fig. 1.22*). The Urethane Counterlung threaded fitting is screwed into the urethane counterlung opening at the top of the counterlung.

The exhalation side DSV attaching hardware is an open port and holds the DSV counterweight in the plastic holder (*Fig. 1.23*).



Fig. 1.21



Fig. 1.22



Fig. 1.23

## Manual Gas Addition Blocks

### Diluent Addition Block

The top of the manual Diluent Addition Block gas supply houses a standard threaded inlet supply hose and returns to the Inhalation T-Piece just below the ADV swivel through a QD connected hose (*Fig. 1.24*). On one side of the block is a blue, un-shrouded gas injection button and on the other side a pronounced relief with a hole for mounting the block as the diver prefers. On the bottom of the block is a secondary in-port for attaching off-board diluent supplies should the diver wish to add such a system.



Fig. 1.24

### Oxygen Addition Block

The Oxygen Addition Block is similar to the Diluent block with a few important tactile differences. The Oxygen addition button is shrouded to prevent accidental injections of Oxygen and so a diver can tell the difference between the two blocks just by feel (*Fig. 1.25*). The gas supply comes from a standard threaded inlet supply hose and returns to the Exhalation T-Piece through a QD connected hose. On the bottom of the block is a secondary in-port for attaching off-board Oxygen supplies should the diver wish to add such a system.



Fig. 1.25

## BATTERY COMPARTMENT COVER

The battery compartment cover (*Fig. 1.26*) is made of Stainless Steel. The cover utilizes two O-rings for redundant water tightness, a radial seal on the lip of the cover and a compression seal on the top of the battery compartment housing.

There is an automatic pressure relief valve built into the top of the cover to vent excess pressure should the battery compartment flood or the solenoid lose gas containment. If the pressure relief valve were ever to actuate because of a battery compartment flood or solenoid gas containment loss, the valve will open to vent the excess pressure and close as soon as the excess pressure has been released.



Fig. 1.26

## BATTERY COMPARTMENT

The battery compartment (*Fig. 1.27*) holds two sets of batteries: two 9V alkaline batteries wired in parallel which powers the solenoid, and one SAFT 3.6 volt LiON (Lithium Ion) battery which powers the Heads Up Display. The Heads-Up Display can also be powered by a 1.5V alkaline battery. The sealed bulkhead power connector at the bottom of the compartment is a female Molex connector. A foam insert holds the batteries in place.



Fig. 1.27

## O<sub>2</sub> SENSORS, SENSOR HOLDERS, CONNECTOR + PINS

The 3 O<sub>2</sub> sensors are located in a chamber above the scrubber basket. This insures a low condensation area and consequently drier O<sub>2</sub> sensors. The sensors have an operating range of 8.5 mV - 14 mV in air and 40.6 mV - 67 mV at 100% O<sub>2</sub> at 1 atm/1.01 bar pressure. The holders are removable to give users better access to the O<sub>2</sub> sensors, wiring harness and connector pins (*Fig. 1.28*). The holders are manufactured from a soft silicone material to help protect the O<sub>2</sub> sensors from vibration and minor impact forces.



Fig. 1.28

Correct placement of the sensors in the head is VERY IMPORTANT to insure moisture does not build up on the sensing face and occlude the passage of oxygen through the hydrophobic membrane and into the water/potassium hydroxide solution. Figure 1.29 shows how the sensor faces should all be pointing in a downward position in the head (red arrows). Notice also that sensor 3 is installed with the back of the sensor pushed through the harness. This gives the wiring harnesses of sensors 2 and 3 more room. Simply push sensor 3 into the holder from the back until it is flush with the holder edge.



Fig. 1.29



**WARNING: IMPROPER MOUNTING OF THE SENSORS CAN CAUSE A BUILDUP OF MOISTURE ON THE SENSOR FACES CAUSING AN IMPROPER READING OF THE OXYGEN CONTENT POSSIBLY LEADING TO SERIOUS INJURY OR DEATH.**

The sensor harness uses robust “medical grade” Molex connectors and silver coated copper stranded wires to insure the best possible connection. However, as with all things that blend electronics and water, extra care should be taken to occasionally clean the connectors and pins with DeOXiT GoldR to insure the best connection. It is also very important to NOT pull the harness out of the connectors by the wires. Doing so almost guarantees you’ll be hunting for a new one in your spares kit!

See the section “Taking Care of your Oxygen Sensors” for more information.

## TAKING CARE OF YOUR OXYGEN SENSORS

*The best way to care for an exotic animal is to first acquire some knowledge about its likes and dislikes, and environments that will help the animal thrive. Likewise, having a working knowledge of what is and is not good for the health of your oxygen sensors will help you take the best care possible of them, and hopefully avoid unnecessary mid-season damage replacement. Here are some important questions, and their answers.*

### **WHAT IS A GALVANIC O<sub>2</sub> SENSOR?**

An oxygen sensor is a very small electrochemical generator. Some people equate them to a battery, but that comparison is largely incorrect since a battery does not produce electricity as the O<sub>2</sub> sensor does, and the O<sub>2</sub> sensor does not store electrical energy as a battery does. Understanding that the O<sub>2</sub> sensor is more like a delicate power-generating machine than a robust Duracell D battery is your first clue in understanding how they should be handled.

### **WHAT MATERIALS ARE USED TO MANUFACTURE THE HOLLIS PRISM 2 SENSORS?**

The body of the sensor is made of High-Density Polyethylene (HDPE). The membrane on the front of the sensor is a thin Teflon gas permeable membrane. The internal components are comprised of a lead anode, a precious metals-plated cathode, a base pH electrolyte consisting of mostly water and a bit of Potassium Hydroxide. A printed circuit board (PCB) with resistor-thermistor temperature compensation circuitry is heat sealed to the outside back of the sensor.

### **WHAT ENVIRONMENTAL CONDITIONS ARE BEST AND WORST FOR THE O<sub>2</sub> SENSOR?**

Your “PSR” series O<sub>2</sub> sensors are happiest between 32 oF/0 °C and 122 oF/50 °C. Operating or storing the O<sub>2</sub> sensor above 122 oF/50 °C will prematurely dry out the electrolytic fluid and destroy the sensor. Operating or storing the O<sub>2</sub> sensor below 32 oF/0 °C will freeze the electrolytic fluid causing expansion damage to the internal components, Teflon membrane, and possibly leakage of the electrolyte upon thawing, thereby destroying the sensor.

## **HOW DOES A CHANGE IN AMBIENT TEMPERATURE INFLUENCE THE O<sub>2</sub> SENSOR'S PERFORMANCE?**

Temperature influences the signal output at a rate of 2.54% per °C. Gradual ambient changes in temperature can be maintained within ±2% accuracy by processing the signal output through the resistor - thermistor temperature compensation network. Rapid changes of 59 °F/15 °C require 45-60 minutes for the compensated signal output to equilibrate, e.g. the electronic thermistor reacts immediately to offset the change in the sensor, but the sensing membrane and electrolyte reacts at a much slower rate.

Because of the exothermic (heat generating) reaction of CO<sub>2</sub> scrubbing taking place next to the sensor housing during diving operations, it is important that you calibrate the sensors close to “room temperatures” (60 °F/16 °C – 80 °F/27 °C) so you are not temporarily outside of the 59 °F/15 °C “rapid compensation” range while diving.

## **HOW DOES PRESSURE INFLUENCE THE OXYGEN SENSOR'S PERFORMANCE?**

Pressure influences the signal output on a proportional basis. The sensor is accurate at any constant pressure up to 30 ATM/30.4 bar provided the sensor (front and rear membranes) is pressurized and decompressed gradually (similar to human lungs). The membranes, especially the front sensing membrane, do not tolerate rapid changes in back pressure or vacuum. Normal diving operations will not generate pressures beyond which the sensor is designed to operate.

If you use a pressure vessel to check current limiting, it is important that you slowly bleed off the pressure in the vessel after the checks are completed. The optimal analysis pressure range is 5-30 psig/ .3 - 2 bar, up to 7 bar/100 psig, with a flow rate of 1-2 cu.ft/h / 28 - 56 l/hr. The longer you keep the cells pressurized, the slower you need to bleed off pressure. This procedure should sound familiar to divers.

## **WHAT IS THE MAXIMUM ALTITUDE THE OXYGEN SENSOR CAN BE EXPOSED AND STILL FUNCTION?**

The oxygen sensors have been tested up to 20,000 ft/6096 m with no error.

## **DOES MOISTURE OR WATER AFFECT THE OXYGEN MEASUREMENT?**

If moisture or water is present in the gas stream it will not damage the oxygen sensor or analyzer, but it can collect on the sensor's sensing membrane, thus blocking the flow of gas.



## WHAT HAPPENS WHEN THE O<sub>2</sub> SENSOR HAS BEEN EXPOSED TO WATER?

The collection of condensation on the sensing surface of the sensor (standing water) reduces the signal output. Once either drying or gravity removes the standing water, the signal output will return to normal within 30 seconds. For example, a thin layer of water over the sensing surface will reduce the signal output of a sensor from 11.8 mV to 10.1 mV within 20 minutes; remove the standing water and the signal output returns to 11.8 mV in 30 seconds.



**WARNING: SALT WATER CAN CORRODE OR BRIDGE ELECTRICAL CONNECTIONS RESULTING IN ERRATIC OXYGEN READINGS.**

## CAN A SENSOR BE CONTAMINATED BY CARBON DIOXIDE (CO<sub>2</sub>) GAS, REDUCING THE SENSOR LIFE?

Exposure of the sensor with its base electrolyte to carbon dioxide (CO<sub>2</sub>) gas or any other acid gas will produce crystallike deposits on the cathode, which reduces the surface area of the cathode and the corresponding signal output. This effect is cumulative, cannot be reversed and can dramatically reduce the expected sensor life. This means that attempting to “Push the Scrubber” beyond its factory-stated duration, or breathing into a loop without active scrubber material installed could shorten the life of your O<sub>2</sub> sensor.

## CAN THE OXYGEN SENSOR BE DAMAGED IF DROPPED OR IF THE REBREATHER IS DROPPED?

Absolutely! Sensors are fragile and can be damaged in a number of ways. Dropping a sensor by itself or while mounted in the rebreather can result in: broken wires, broken electrical connections, dislodging the anode. Dislodged anodes cause a broken connection or an internal short as the loose anode comes in contact with the cathode connection. If the motion stop-force is applied onto the sensor face, the liquid electrolyte can be forced onto the Teflon membrane, stretching the material and destroying the sensor. Testing has shown that dropping a sensor one time from 3 ft/1 m onto a carpeted concrete slab can result in an immediate 25-100% reduction in signal output.

Types of forces known to cause sensor damage while housed in a rebreather include but are not limited to transportation shock (baggage handler throwing distance competitions, driving over rough terrain, jolts during heavy seas and extreme motor vibrations). It is always recommended that you temporarily remove the sensors from the rebreather if it may be subject to any of the above conditions.



## **CAN I TOUCH THE TEFLON MEMBRANE WITH MY FINGER? HOW DO I CLEAN THE SENSOR CONTACTS?**

No, you must not touch the sensor face with anything, especially your fingers. Fingers have oils on them even when freshly washed, and the oil permanently clogs the membrane, destroying the sensor. If salt has dried on the sensor face, you can gently pour a bit of distilled water on the membrane and allow it to air dry. Never use any cleaning solutions on the sensor face. You may use an electronics contact cleaner such as DeoxIT® GOLD GN5 on the contact pins, but use it sparingly and wipe off all residual cleaner before use.

## **WHAT IS THE EXPECTED OXYGEN SENSOR LIFE?**

The operational life of the Hollis (PRISM 2) sensors are calculated as one year from the date they are put in service. There is a “DO NOT USE AFTER” (date) also. Whichever date comes first is the proper time to discontinue sensor use. DO NOT attempt to extend the life of the sensors. Doing so can result in incorrect, erratic, or no signal output which can lead to serious injury or death.

## **WHAT IS THE RECOMMENDED STORAGE TEMPERATURE?**

During a “diving season” (if one exists for you) the oxygen sensors, when stored, should be kept in a cool, ambient, unsealed environment to insure they are immediately operational. If you will be storing the sensors for a month or more, you can place them in an airtight container in a refrigerated environment that is kept above 34 °F/0.1 °C to insure that the electrolyte does not freeze (see “Environmental Conditions”). While this will not extend the operational life of the sensor, it may reduce response time degradation during the latter part of its 12-month service life.

After storage, you will need to acclimate the sensors by placing them in air at room temperature for 24 hours prior to putting the sensors back in service. Failure to acclimate the sensors after storage can cause the sensors to read incorrectly and possibly lead to injury or death.

## ARE THE O<sub>2</sub> SENSORS DATE CODED?

Oxygen sensors have a finite life. Understanding the date code is vital to getting the benefit of the warranty period. As an example, the serial number 10734789 breaks down as follow: Digit #1 a (1) denotes the year of manufacture as 2011; digits #2, #3 (07) indicate July as the month of manufacture; the remaining digits are sequential for uniqueness. As the result of a number of issues related to the use of aged sensors, Analytical Industries has added a “DO NOT USE AFTER: (date)” to the sensor’s labeling. For a sensor with less than 12 months in service, this date supersedes. If the sensor is past the “DO NOT USE AFTER: (date)”, discontinue use of the sensor. DO NOT use it regardless of how it seems to perform.



**WARNING: YOU MUST NEVER USE OXYGEN CELLS BEYOND THEIR EXPIRATION DATE OR TWELVE MONTHS OF SERVICE, WHICHEVER COMES FIRST.**



**WARNING: ALWAYS ACCLIMATE NEW SENSORS TO AMBIENT AIR FOR A MINIMUM OF 24 HOURS BEFORE CALIBRATION OR USE.**

## SOLENOID

The PRISM 2 solenoid (*Fig. 1.30*) is a low power (0.65 watt) normally closed electromagnetic valve mounted in an isolated compartment in the head. The normally closed solenoid will only allow gas to flow when an electrical current is applied and the valve is momentarily opened.

Operational failure or loss of adequate voltage to open the solenoid valve will keep oxygen from flowing into the system. While the solenoid is “normally closed” debris finding its way into the valve, rust from flooding, or poor maintenance could cause the valve to fail in an open position. If this were to occur, the loop would quickly flood with a potentially dangerous level of oxygen. It is very important that the micron filter at the hose fitting is in place at all times and properly maintained. Oxygen flows from the solenoid body directly into a channel that leads from the solenoid into the head plate in the head.

All electrical components of the solenoid are external to, and isolated from the breathing loop.

The solenoid chamber (*Fig. 1.31*) is designed that, should the solenoid ever lose gas containment, gas vents to the outside environment through the battery cap over-pressure valve. There are no user serviceable parts in the solenoid compartment, and only factory authorized repair technicians should replace the solenoid.

## SOLENOID ELECTRICAL CONNECTIONS

The Molex electrical connector for the solenoid is found in the electronics module and connects through a bulkhead into the sealed solenoid compartment (*Fig. 1.32*). There are no user serviceable parts inside either compartment, and these compartments should only be opened by a factory authorized service technician.

## SOLENOID O-RINGS

The solenoid is sealed by two O-rings (*Fig. 1.33*). The outer O-ring seals out water, and the inner O-ring keeps the oxygen contained within the solenoid. The O-rings are replaced during routine annual service, if required, by an authorized PRISM 2 service technician and are therefore not considered user-serviceable parts.



**CAUTION:** THE OXYGEN SOLENOID IS A SAFETY-CRITICAL PART. SHOULD IT MALFUNCTION, REPLACEMENT BY A FACTORY AUTHORIZED SERVICE TECHNICIAN IS REQUIRED. NEVER ATTEMPT TO REPAIR A MALFUNCTIONING SOLENOID



Fig. 1.30



Fig. 1.31



Fig. 1.32

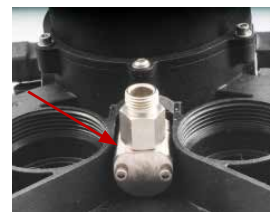

Fig. 1.33

## THE SOLENOID +THE PID CONTROLLER

The PRISM 2 Solenoid is controlled by state-of-the-art PID Control loop feedback circuitry (The Controller). The PID Controller makes calculations based on an error value which is calculated as the difference between a measured process variable (how much oxygen is in your loop) and a desired setpoint (the O<sub>2</sub> setpoint). It also considers the history of what has occurred previously, and makes predictions about what may occur in the future, constantly making adjustments to its algorithms accordingly. Sometimes called a “Three Term Controller”, the P, I and D stands for Proportional - Integral - Derivative.

A familiar example of a control loop is the action taken when adjusting hot and cold faucets (valves) to maintain the water at a desired temperature. This typically involves the mixing of two process streams, the hot and cold water. The person touches the water to sense or measure its temperature. Based on this feedback they perform a control action to adjust the hot and cold water valves until the process temperature stabilizes at the desired value.

The sensed water temperature is the process variable or process value. The desired temperature is the setpoint. The input to the process (the water valve position) is the variable. The difference between the temperature measurement and the setpoint is the error and quantifies whether the water is too hot or too cold and by how much.

After measuring the temperature, and then calculating the error, the controller decides when to change the tap position and by how much. When the controller first turns the valve on, it may turn the hot valve only slightly if warm water is desired, or it may open the valve all the way if very hot water is desired. This is an example of a simple proportional control. In the event that hot water does not arrive quickly, the controller may try to speed-up the process by opening up the hot water valve more-and-more as time goes by. This is an example of an integral control.

Making a change that is too large when the error is small is equivalent to a high gain controller and will lead to overshoot. If the controller were to repeatedly make changes that were too large and repeatedly overshoot the target, the output would oscillate around the setpoint in either a constant, growing, or decaying sinusoid. If the oscillations increase with time then the system is unstable, whereas if they decrease the system is stable. If the oscillations remain at a constant magnitude the system is marginally stable.

In the interest of achieving a gradual convergence at the desired temperature, the controller may wish to damp the anticipated future oscillations. So in order to compensate for this effect, the controller may elect to temper its adjustments. This can be thought of as a derivative control method.

If a controller starts from a stable state at zero error, then further changes by the controller will be in response to changes in other measured or unmeasured inputs to the process that impact on the process, and hence on the process variable.

Variables that impact on the process other than the manipulated variable are known as disturbances. Generally controllers are used to reject disturbances and/or implement setpoint changes. Changes in feed water temperature constitute a disturbance to the faucet temperature control process.

In theory, a PID controller can be used to control any process which has a measurable output, a known ideal value for that output and an input to the process that will affect the relevant process value. PID controllers are used in industry to regulate temperature, pressure, flow rate, chemical composition, speed and practically every other variable for which a measurement exists.

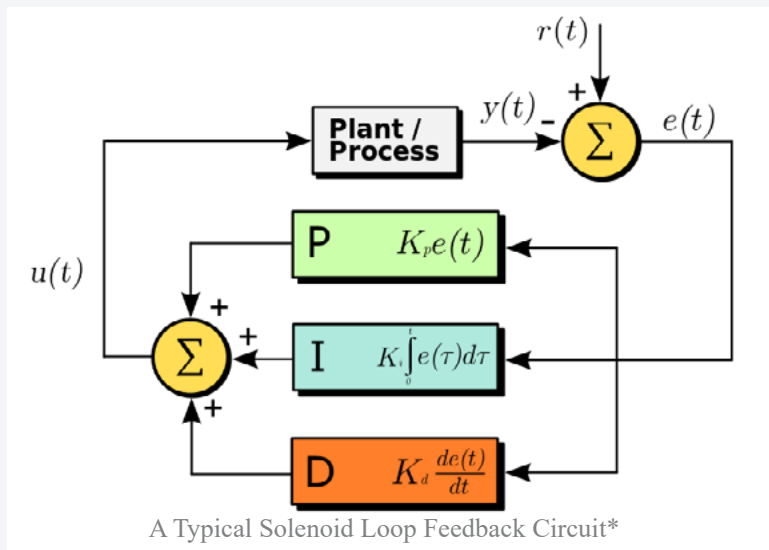

\*Source: Wikipedia

## BUCKET O-RINGS

There are two red bucket sealing O-rings (*Fig. 1.34*) for redundant sealing of the breathing loop. Standard user maintenance during system set-up and tear-down are required.



**WARNING: FAILURE TO CHECK, CLEAN AND REPLACE THE BUCKET SEALING O-RINGS AT THE FIRST SIGN OF WEAR CAN LEAD TO A CATASTROPHIC FLOOD OF THE SYSTEM LEADING TO INJURY OR DEATH.**

## BUCKET LATCHES

There are 3 Nielson Sessions Stainless Steel locking latches mounted on a stainless steel band (*Fig. 1.35*) that hold the bucket securely onto the head assembly. While two latches will hold the bucket securely, it was felt that redundancy here was critical.

## BASKET SPRING ON BUCKET

The absorbent basket is pressure-sealed onto the Red CO<sub>2</sub> Seal under the head by the bucket spring assembly (*Fig. 1.36*) at the bottom of the bucket. The spring creates the seal between the basket and Red CO<sub>2</sub> Seal and also reduces vibration on the basket during transit.



**WARNING: PROPER SPRING TENSION IS CRITICAL FOR SAFETY AND AN EFFECTIVE SEAL. ONE THREAD SHOULD BE EXPOSED ABOVE THE LOCKNUT AS SHOWN. FURTHER INSTRUCTIONS ARE AVAILABLE IN THE USER SERVICE GUIDE.**

## ABSORBENT BASKET ASSEMBLY

The absorbent basket is comprised of six pieces (*Fig. 1.37*). The basket outer cage that supports the nylon absorbent-retaining mesh, a screw-in center tube and O-ring. It also supports the nylon mesh and a screw-on cover. Two foam pads must be installed top and bottom prior to filling the absorbent basket. The bottom pad has a larger center diameter hole than the top pad. The foam pads impede the flow of gas against the smooth surfaces of the basket top and bottom, hindering any potential gas channeling in these areas.

The gas flow vanes built into the top of the scrubber basket create an area of increased gas velocity within the O<sub>2</sub> sensor area of the head, reducing the dew point of the gas around the O<sub>2</sub> sensors. The reduction in condensing humidity in this critical area helps reduce the potential for water to condense on the surface of the hydrophobic membrane of the O<sub>2</sub> sensor.



Fig. 1.34



Fig. 1.35



Fig. 1.36



Fig. 1.37

## BACKPLATE

The Hollis PRISM 2 can be outfitted with any industry standard technical style backplate. The unit is currently shipped from the factory with a Hollis Stainless Steel Backplate and Solo Harness (*Fig. 1.38*). The style of threading, for the webbing on the backplate, is left to user preference and personal adjustment.

## OXYGEN AND DILUENT FIRST STAGES

All PRISM 2 first stages (*Fig. 1.39*) have been oxygen cleaned and assembled in a clean room environment with specially designed materials, halocarbon-based lubricants and color-coded for easy identification on and off the PRISM 2 chassis (Green=O<sub>2</sub>, Black=Dil).

PRISM 2 O<sub>2</sub> first stages are equipped with a M26 fitting when shipped to the European market. This is in compliance with EN 144-3 requirements that regulators with oxygen mixtures greater than 21% use a M26 fitting. Non-CE countries are outfitted with 300 BAR/4500 PSI EN144-3 connections.

First stages are custom designed with a port block consisting of 2 medium pressure ports for the oxygen first stage and 4 medium pressure ports for the diluent first stage, and both with 1 high pressure port. The working Intermediate pressure of both first stages is 140 to 145 psi / 9.7 to 10 bar. All First stages are equipped with pressure relief valves (*Fig. 1.40*). The valves reduce the likelihood of an uncontrolled increase in intermediate pressure causing a freeflow of gas into the breathing loop. The first stage pressure relief valve is not a user serviceable part.

The oxygen feed lines to the solenoid and manual O<sub>2</sub> addition valve incorporate inline flow restrictors to meter the flow of oxygen into the breathing loop. The restrictors must not be removed.

## GAS CYLINDERS

The Hollis PRISM 2 does not include cylinders, but these should be purchased from your local Hollis Rebreather dealer. The suggested on-board gas cylinder configuration is two 3-liter Steel Cylinders (one oxygen, one diluent), with 232 bar maximum allowed pressure cylinders compliant with the Pressure equipment directive (PED) and recognized standards. These can be ordered under the following part numbers:

Diluent 3 Liter Faber cylinder - Part number #AP6H

Oxygen 3 Liter Faber cylinder - Part number #AP6HOC

Diluent Valve - (Black Hand Knob, 5/8 BSP connection) Part number #RB13

Oxygen Valve - (Green Hand Knob, M26x2 connection) Part number #RB13A/G

Oxygen valves have a M26x2 connection, in accordance with EN144-3 and Diluent valves have a G5/8 (5/8 BSP) connection, in accordance with ISO 12209. Air Diluent gas should be used to a maximum depth of 40m and trimix gases should be used to a maximum depth of 100 m using a Trimix 9/60. The duration of the diluent gas depends on the depth and activity of the diver. Oxygen Cylinder Gas is estimated to last approximately 280 minutes, if the diver consumes 1.6 liters of oxygen per minute. (3 liters x 200 bar = 600 liters - 25% reserve = 450 liters, 450 liters/1.6 liters/min = 281 mins.)

Low pressure and high pressure hoses supplied are measured to reach cylinder valves when assembled in the downward facing position, shown in figure 1.40.1.



Fig. 1.38



Fig. 1.39



Fig. 1.40



Fig. 1.40.1

## FITTING YOUR PRISM 2

Your PRISM 2 rebreather should be fitted to you with the same attention as you would any other fine (and very expensive) custom-made piece of clothing. A properly fitted rebreather will perform more consistently with better all around breathing characteristics, have less hydrostatic imbalances in all diving positions, less strain and fatigue on spinal musculature and better diver trim while diving.

The fitting process begins before you even set-up the PRISM 2. First you must assess your body type, as that will give you a starting place for making close approximations to what will be the final, best fit.

The standard counterlung yoke fits a wide range of body types, and generally anyone between 5ft to 6ft/ 1.5-1.8m tall with a standard torso will find a best fit using the standard counterlung yoke. At the upper ranges of that measurement, a person with a long torso, or anyone taller than 6' will probably find that the Long yoke works best for them. If you have any questions, or need help finding which set-up works best for you, ask a PRISM 2 Instructor, or go into your local Hollis dealer. They will be more than happy to help you get your rebreather properly fitted.

Once you have decided which yoke should work best, you will begin testing out the different variables such as backplate position (2 available), Wing position (3 available) and three positions on the yoke, which will dictate where the counterlungs sit on your chest.

First look at the backplate. The harness webbing should be adjusted so the top of the backplate sits about 4 to 6 inches / 10.2 to 15.2 cm or so below your shoulders. Next, put the counterlungs on the yoke. Take the assembly and put it on so the yoke hangs over the backplate while holding the counterlungs on your chest. The center of the DSV assembly breathing hose holes should be level with your collar bones.

Proper fit is the first element in a rather complex dance with physics. These few pointers should give you a good starting place in custom fitting the Hollis PRISM 2 for best fit. Don't be afraid to experiment with placement as the ultimate goal is diver comfort. Once you have a fit that you feel will work for you in the water, we need to examine how and where to distribute any weight you will require to get you the best in-water "stability" possible.



## STABILITY

ARTICLE BY GERARD NEWMAN

What is stability? Briefly, it's the ability to choose and maintain your position in the water column. When we have a stable platform for diving we are more comfortable, in better control and better able to observe our underwater surroundings. Diving with a CCR adds some additional considerations for stability. Ideally, we should be stable when swimming (dynamic stability) and when hovering (static stability). We have better control over our stability when we assume prone (horizontal) trim in the water with our fins flat. This increases our vertical drag (helping to maintain our vertical position in the water column) and decreases our horizontal drag (as when swimming) (*Fig. 1.41*).



Fig. 1.41

Stability is affected by weighting and buoyancy. Our weighting components include the cylinders we choose to dive with, lights, fins, backplates and lead ballast that we carry with us. These components may be distributed from side to side and head to toe. Improper distribution will result in non-horizontal trim. Too much lead at our waist will tend to drag our hips down resulting in a head-up position in the water (*Fig. 1.42*). Fins that are too light will result in a feet-up position. Divers often instinctively compensate for weight placement problems by arching their backs to maintain trim.

The objective is to allow proper trim with a relaxed posture in the harness. Of course proper weighting is key – we should be able to maintain a 10 ft/3m stop with no gas in the wing and a comfortable amount of gas in our exposure suit (when diving a drysuit). With the CCR we have to account for the gas volume in our breathing loop. I typically recommend starting with an extra 4 lbs/1.8kg over what the diver would normally wear with a single cylinder open circuit rig as a starting point. Divers with larger or smaller tidal volumes will need to adjust accordingly.



Fig. 1.42

Our buoyancy components include our exposure suit, our wing, and our counterlungs. Minimizing the gas volumes in each will go a long way towards minimizing the effects of Boyle's Law. The larger the gas bubble, the harder it is to control. The shallower you are, the more pronounced the effects of Boyle's Law – careful attention to controlling the gas volumes in our counterlungs, wing and our exposure suit on ascent is critical. Adding or re-moving small amounts of gas and allowing time for the change to take effect is the key to controlling our buoyancy (*Fig. 1.42 & 1.43*).



Fig. 1.43

Counterlung position should be such that they are as close to your lungs as possible, both in the vertical and horizontal planes (*Fig. 1.44*). This will minimize static lung loading and decrease the work of breathing. The bottoms of the front mounted counterlungs should be secured to the waist strap to hold them in place when they are inflated and become buoyant. For most divers the elbows on the counterlungs should be positioned at the collarbones, with the chest strap tightened to control their horizontal position. Back mounted counterlungs should be positioned so that the center of the T-Pieces rest at the collar bone, or slightly above. Gas volume in the counterlungs will affect both your buoyancy and trim. Too much gas in the counterlungs will result in head-up trim; too little will result in head-down trim (and difficulty taking a full breath). With practice one can become proficient at adding and removing gas from the breathing loop to maintain horizontal trim and neutral buoyancy.



Fig. 1.44

The wing may be positioned to increase buoyancy towards our head or our feet if needed to adjust our trim. Weights can be placed near the shoulders to provide a counterbalance to the counterlungs and help keep us prone in the water with minimal effort.

The backplate should be positioned such that the top of the plate is easily reachable with the tips of your fingers if you swing your arms back with your elbows next to your ears. On most people this will position the backplate at the top of the scapulas. Straps should be loose enough to allow full range of movement of your arms across the chest and allow you to “chicken wing” into and out of the harness. The crotch strap should be adjusted to keep the rig stable – tight, but not too tight. If the crotch strap is pulling the waist strap down then it is too tight and needs to be lengthened (*Fig. 1.45*).



Fig. 1.45

A very helpful technique is to have someone shoot some video of you while hovering and while swimming. Reviewing this video can help identify where your buoyancy or trim needs adjusting. A good Intro to Tech instructor can also be very helpful.

## SETUP

### AN O-RING CLEANING PRIMER

O-Rings are an integral component of almost every part of a functioning rebreather and as such, you must be adept at properly inspecting and caring for them. For the sake of brevity we will give you a generic description of how to prepare the O-rings in the Hollis PRISM 2 for use, below. In the checklist “step-by-step” to follow, unless there are unusual design, access, or handling considerations for a particular O-ring, we will simply state,

*“Remove, clean and prepare the O-ring(s), O-ring groove and mating surface for use, or replace if worn or damaged.”*

Remove the O-ring from the O-ring channel using a non-metal O-ring removal tool (*Fig. 2.1*) being careful not to over-stretch the O-ring. Never use a sharp metal O-ring pick or any metal object as that can damage the O-ring, the O-ring groove or O-ring mating surface.

#### NOTE: O-RING REMOVAL TIP

While squeezing opposite sides of an O-ring, slide both sides in the same direction. This will create a protrusion of the O-ring on that side that you can grab with your fingers, to roll it out of the groove. If necessary, the tapered end of a plastic Zip Tie can be used to help pull an O-ring up and out from its groove.

Clean the O-ring with a soft, dry lint-free cloth, (*Fig. 2.2*) being careful to remove any debris and old lubricant. Run your fingers around the O-ring feeling for uneven surfaces, abrasions, sand or other debris that could cut the O-ring. If you see or feel any damage, replace the O-ring. Never dive with a damaged O-ring, as a flood may result.

Clean the O-ring channel and area surrounding the channel of debris and old lubricant (*Fig. 2.3*). Place a small amount of lubricant on your finger and coat the O-ring lightly. Inspect the O-ring to make sure there is no debris, lint or hairs on it. Carefully replace the O-ring in its cleaned O-ring channel.

Make sure to clean the O-ring’s mating surface (the surface the O-ring seals against) of all lubricant, dirt and lint.



Fig. 2.1



Fig. 2.2



Fig. 2.3

## PACKING THE PRISM 2 CO<sub>2</sub> SCRUBBER

To pack your PRISM 2 scrubber, you will need the following items:

(Fig. 2.4) • 1 towel

- Paper towels or newspaper sheets
- 1 ea. top and bottom absorbent basket foam pads
- Approximately 6 lbs (2.7 kg) fresh unused 8-12 CO<sub>2</sub> absorbent\*
- 1 pair surgical gloves
- 1 painter's or surgical mask
- 1 eye protection

\* See PART 5 section 2 for list of approved adsorbent material.



Fig. 2.4

The PRISM 2 scrubber is easy to pack, and with experience should only take 5 to 10 minutes from set-up to clean up.

Find a dry area away from and downwind of other people. If necessary, take a moment to let people around you know that you will be working with caustic materials, and request they stay upwind from where you will be working.



**WARNING: IF YOU EVER INGEST CO<sub>2</sub> ABSORBENT DUE TO HANDLING MISHAPS OR A LOOP FLOOD, KNOWN AS A “CAUSTIC COCKTAIL”, IMMEDIATELY SEEK EMERGENCY MEDICAL TREATMENT AND DRINK COPIOUS AMOUNTS OF WATER. DO NOT INDUCE VOMITING UNLESS INSTRUCTED TO DO SO BY MEDICAL PROFESSIONALS. (FOR MORE INFORMATION DOWNLOAD THE LATEST MATERIAL SAFETY DATA SHEET FROM THE PRODUCT MANUFACTURER, OR CONTACT YOUR LOCAL POISON CONTROL CENTER.)**

Spread out a towel or other soft covering on the ground in a flat area, and lay a few sheets of paper towel or newspaper on top of that. Place the bottom foam pad (larger center hole) in the basket making sure it lays flat against the bottom and sides of the basket (*Fig. 2.5*). Take a piece of paper, golf ball or absorbent container cap and cover the top of the center tube. This will keep absorbent from going down the center tube as you pour it into the scrubber basket. (*Fig. 2.6*)

Pour the absorbent slowly from about 12" above the basket, allowing the wind to carry off any dust. The absorbent should be granular and not produce much dust while pouring (*Fig. 2.7*). If the material looks crushed or is exceptionally dusty, don't use it, as that can be an indication that the absorbent has been mishandled and may not scrub CO<sub>2</sub> properly during a dive.

Continue pouring until the absorbent reaches the first horizontal brace on the basket (*Fig. 2.8*). Unless you were exceedingly careful, some material will have fallen onto the paper around the basket. Lift the basket off the paper and pour the granules from the paper into the basket. If the material on the paper is mostly dust, dispose of it carefully rather than pouring it into the basket.



Fig. 2.5



Fig. 2.6



Fig. 2.7



Fig. 2.8

With the basket on the towel-covered ground, gently begin tapping the basket where the vertical and horizontal braces meet (Fig. 2.9). This will begin to settle the granules in the basket. The trick is to tap hard enough on the cross braces that the vibrations cause the material to settle, but not so hard that the granules jump around. Make sure you do not tap the mesh as that will only displace the material from the sides.

While tapping the cross braces, rotate the basket so you tap all sides of the basket. Spend at least a minute tapping the basket sides. You may notice that the absorbent level drops as the granules settle.

Repeat the filling process up to the second horizontal brace, then tap to settle the granules as before. Repeat the filling process to the top of the bucket, leaving a small hill of absorbent on the top (Fig. 2.10). Tap and settle the material as before. You will probably be able to settle this material until it is almost level with the basket top.

Once the basket appears to be full, pour a few extra mound of absorbent onto a cup or other small container and put it aside. (A mask box works well!) Remove the material you used to block the center tube.

Lay the top foam pad (smaller center hole) on top of the mound of absorbent, and place the basket cover on top of the foam pad (Fig. 2.11). Slightly tighten the basket top onto the first threads. Do not force the top on. If you cannot easily start the top onto the basket threads, remove a bit of absorbent and try again.

Once you have started the top onto the basket threads, clean the towel of loose absorbent, then pick up the basket by the top horizontal brace and using your thumbs to hold the basket and top together securely, lift the basket a few inches above the ground and tap the basket slowly and firmly 3 times on the towel covered ground (Fig. 2.12). Never tap the basket on uncovered ground, as that can damage the basket to exhale plenum sealing surface (Fig. 2.13). The sealing area on the basket must be kept clean of caked-on absorbent, so don't tap the basket down on loose absorbent. Doing so will just make extra work and make any post-packing scrubber basket cleanup take longer.



Fig. 2.9



Fig. 2.10



Fig. 2.11



Fig. 2.12



**CAUTION: RESIST THE URGE TO BLOW ON THE PACKED BASKET TO GET RID OF DUST, AS THE DUST WILL GET IN YOUR EYES, NOSE AND THROAT.**



Fig. 2.13



### 3 TAPS THEN TURN

*Once you have tapped the basket 3 times on the ground, turn the basket top until it makes contact with the absorbent. Do not force the top! Tap 3 times again and turn the top. Repeat this process until the top is sealed completely on the threads.*

Using the 3 tap and turn method will insure that you do not over-pack the bottom of the basket while leaving the top material loose. Also, making a repeatable process your habit will insure that all you are packing your scrubber consistently.

**Arbitrary methods lead to arbitrary results!**

Remove the top and foam pad, and using more of the absorbent you set aside on the paper, refill the basket until you again have a small mound of absorbent on the top. Replace the foam pad, seat the top onto the basket threads, and repeat the process.

Once you have fully seated the top onto the basket a second time, check the firmness of the material. The top and bottom of the basket should be equally firm and you should not be able to displace absorbent grains by applying moderately firm pressure against the mesh. If the top is not as firm as the bottom, turn the basket upside down and tap three times on the basket top. If the material is still loose or unevenly packed, open the basket, add some more absorbent and repeat the process then check firmness again.

Once the basket is packed to your satisfaction, use a clean paper towel to carefully remove any dust collected on the outside of the basket. Collect any left over absorbent that you had set aside for packing and if it is not dusty, you may pour it back in the absorbent container. Seal the absorbent container and store it in a cool, dry place.



**NOTE:** There is no set number of times you will need to remove the basket top to add material, but spending more time settling the material as you fill the basket will help reduce it.

## PRE-PACKING THE PRISM 2 SCRUBBER

While prepacking the scrubber well in advance of a dive, or transporting packed scrubbers is not advised due to potential absorbent settling issues, we recognize there are instances where packing a scrubber on-site is either impractical or impossible.

If you will not be using the packed scrubber immediately, put the basket in an airtight container and seal the container. Put tape across the seal on the outside of the airtight container and write your name, the date you packed the basket, and the absorbent material used (Fig. 2.14). Since this is a fresh fill write “0 hours used” on the tape. Store the container in a cool, dry place. After short-term storage or transportation, you must check the scrubber for settling or loose scrubber material prior to installing it in the rebreather.



Fig. 2.14



**NOTE:** To avoid damage, use only factory tested cleaning solutions. See list of approved cleaning solutions in the PART 5 Section 2 for further information.

## CLEANING YOUR EMPTY SCRUBBER

After use, it is always a good idea to wash and dry the scrubber basket, basket pads and bucket to remove residual dust and used absorbent. Use fresh water and make sure to wash out any loose granules.

If you notice that the threads of the basket or top are becoming clogged by crushed, caked absorbent dust or the absorbent is beginning to cake-up (Fig. 2.15), you will need to soak the top and basket threads in white vinegar for 15 to 30 minutes, which will dissolve the caked on absorbent and return the basket to like-new condition. Heating the vinegar to 120 °F/49 °C will make it work faster, but will make you unpopular with anyone close by. Wash the cleaned parts thoroughly with fresh water until the smell of vinegar is completely gone.



Fig. 2.15

## DISPOSING OF USED CO<sub>2</sub> Adsorbent

You have probably heard that used absorbent is simple calcium carbonate, the same stuff seashells and reefs are made from. Eventually that will be true, but even spent absorbent is still highly caustic and will be for some time. Never dump freshly spent absorbent in the ocean! It is best to find a covered pail or a garbage bag in which to store the spent material, and mark the container as containing a caustic substance.



**WARNING: IF YOU DO NEED TO STORE THE SCRUBBER OR TRANSPORT IT TO YOUR DIVE SITE, YOU MUST CHECK THE SCRUBBER BASKET FOR ABSORBENT MATERIAL SETTLING PRIOR TO INSERTING IT IN THE REBREATHING. IF THE ABSORBENT SEEMS LOOSE AT ALL, TOP-OFF THE BASKET WITH ADDITIONAL ABSORBENT PRIOR TO USE. FAILURE TO INSURE A PROPERLY PACKED SCRUBBER MAY LEAD TO INJURY OR DEATH.**



# USING CHECKLISTS

## THE IMPORTANCE OF USING YOUR CHECKLISTS

*Imagine you are sitting on a commercial airliner watching the pilot ready the plane for takeoff. The copilot turns to the captain and asks if he is ready to go through the pre-flight checklists. The pilot does a cursory scan of the cockpit, turns to the copilot and says, "Everything looks good to me, we can skip them". How comfortable would you feel flying at 32,000 feet with that captain at the controls?*



**NOTE:** Don't allow yourself to become rushed or distracted when setting up or working on your rebreather. An inattentive rebreather diver is an accident waiting to happen. Take your time while setting up your rebreather and when diving.

## CASE STUDY OF A CLOSE CALL

A rebreather diver, self-described as being "very experienced" with his rebreather, has completed two 1 1/2 - hour dives. He changes out the scrubber with fresh absorbent to complete a third 2-hour dive later in the day. He reports that he was feeling "rushed" because he was delaying his buddies from lunch. After quickly repacking the scrubber, relying on memory instead of his checklist, he reassembles the rebreather and then joins his buddies.

An hour after lunch, he dons the rebreather and enters the water. After completing his 15 ft/ 4.5m checks, he descends to 35ft/10.6m whereupon he begins to feel short of breath. Still clear-headed enough to realize this could possibly be a sign of CO<sub>2</sub> toxicity, and deciding to err on the side of caution, he bails out to open circuit and aborts the dive.

Once safely back, the diver disassembles the unit and finds that an O-ring sealing the breathing loop is missing, allowing his exhaled gas to bypass the scrubber completely and enter the inhalation side of the rebreather.

Fortunately, due to his quick actions, this incident resolved without tragedy.

## LESSONS LEARNED

In his on-line report, the diver stated he had learned a hard lesson from this life threatening incident. The first and most obvious was he had not followed his training, relying on his memory instead of using the checklist. He also reported that "to be honest", this was not the first time he had skipped using a checklist. He vowed never to make that mistake again.



**WARNING: THE IMPORTANCE OF WORKING WITH CHECKLISTS WHEN SETTING UP YOUR PRISM 2 CANNOT BE OVERSTATED! IF YOU HAVE NOT SET-UP YOUR PRISM 2 USING THE CHECKLISTS, DO NOT DIVE THE REBREATHING.**

## WHY A MULTIPLE LIST FORMAT

One thing that became clear to us as we talked to rebreather divers about their use of checklists was that a simple, one-size-fits-all checklist often does not follow the stages in which they normally set-up their rebreathers. The checklist becomes an encumbrance to safety if divers have to skip around the checklist, checking off only those items needed to get to the next phase.

For instance, some divers set-up and test their rebreather days in advance of the dive, and leave the rebreather assembled during transport to a dive site. A start to finish checklist may not take into account the checks required once the unit arrives at the site.

We have broken the PRISM 2 checklists into 4 distinct sub-lists which should follow the steps encountered in the majority of real world diving situations.



**NOTE:** It is always recommended that you do a full set-up and “pre-dive” check before any trip, as that is the only sure way to verify all systems are fully functional.

To follow is the group of 4 “expanded” checklists, which includes the incremental steps you need to complete each step on the checklist. The lists are broken out as follows:

**“PRISM 2 Component Inspection”, “PRISM 2 Assembly Order” and “PRISM 2 Operational Checklist”.**

The fourth sub-section of the operational checklist, **“Immediate Pre-dive Checks & System Settings”** are for final “systems go” verifications prior to entering the water.

**You can use the 3 main sections individually as follows:**

#### **PRISM 2 Component Inspection:**

This section of the checklist is used to help you verify that all parts of a complete PRISM 2 are present and visually undamaged prior to packing it for transport. There is nothing worse than boarding a local dive boat or landing in a foreign country just to find out that you left your DSV in your dive locker back home.

#### **PRISM 2 Assembly Order:**

This is the list you will normally use to “build your rebreather” from its component parts.

#### **PRISM 2 Operational Checklist:**

This is the checklist you will use to test all assembled components of the rebreather to make sure they are functioning properly as a whole prior to entering the water. You will complete these steps after assembly, or if a piece of the functioning rebreather has been disassembled at any time. This is the most critical part of the entire set up process, since a non-functional rebreather will always become evident at some point as you go through the operational checks. Do not dive the rebreather if it has not passed every step of this checklist.

#### **Immediate Pre-dive Checks & System Settings:**

These are the final few checks done with the unit secured to your body before jumping in the water. While most checks are verifications of previously checked items, it is absolutely imperative that you check these again before entering the water.

# COMPONENT INSPECTION CHECKLIST

## KEY:

W = WEAR / O = OPERATION / I = INSTALL

### 1. Check H-Plate / Harness / BC for Wear, Damage or Missing Parts

- A. H-Plate
- B. Harness (W)
- C. Fabric (W)
- D. Inflator / Alt. Air Source (O)
- E. Dump Valve(s) (O, W)
- F. Removable Weight Pockets (W, I)
- G. Fastening Clips (W)

### 2. Inspect Counterlungs - FMCL/BMCLs

- A. Fabric (W)
- B. Drains (O)
- C. Threaded DSV Assembly Rings (W)
- D. Breathing Hoses, Oetiker Clamps, + O-Rings (W)
- E. Manual O<sub>2</sub> & Diluent Addition Valve (I, O)
- F. Automatic Diluent Valve (ADV) (O)
- G. Over-Pressure Valve (OPV) (O)

### 3. Inspect DSV Breathing Hoses

- A. Hoses,
- B. Oetiker Clamps (W)
- C. O-Rings (W)
- D. T-Pieces (O,W)
- E. Inhalation Hose Mushroom Valve (only on inhale hose for DSV supplied systems) (O, W)

### 4. Inspect DSV

- A. Shut-Down/OC Assembly (O)
- B. Water Drain (O)
- C. Mouthpiece, Zip-Tie
- D. DSV Exhalation Mushroom Valve (O,W)
- E. Inhalation Hose Mushroom Valve (O, W)

### 5. Inspect Regulators + Hoses

- A. 1st Stages (W)
- B. Pressure Relief Valves
- C. LP Hoses + Connectors (W)
- D. HP Hoses + Connectors (W)
- E. Diver Installed Gas Supply Hoses (if installed)
- F. Pressure Gauges

### 6. Inspect Wiring

- A. Heads Up Display (W)
- B. Wrist Display (W)

### 7. Battery Compartment, Batteries + O-Rings

- A. Solenoid Batteries (I)
- B. Heads Up Display Battery (I)
- C. O-Rings (2) (W)
- D. Cover, Cover Latches + Keepers (O,W)

### 8. Solenoid Operation (O)(If proceeding immediately to assembly and operational checks, you can skip this step.)

### 9. Inspect Head Assembly

- A. Red CO<sub>2</sub> Seal (I, W)
- B. Head To Bucket O-Rings (2) (W)
- C. O-Ring Seats (W)
- D. Latch Keeper (W)
- E. Nut Bars, Head Bolts, Head Cover Bar + Head Cover (W, I)

### 10. Oxygen Sensors

- A. 3 Oxygen Sensors + Sensor Holders Installed (I)
- B. Oxygen Sensor Wiring Harness (I)
- C. mV Readings Within Range (O) (8.5 mV to 14 mV in air)

### 11. Bucket Assembly

- A. Basket Compression Spring + Pad (I)
- B. Latches (3) (W, O)
- C. 1 Moisture Pad (I)

### 12. Basket Assembly

- A. Check Mesh (W)
- B. Center Tube O-Ring (I)
- C. Top + Basket Threads Clean (O)
- D. Top + Bottom Foam Pads (I)

## COMPONENT INSPECTION CHECKLIST: DETAILS

### KEY:

W = WEAR / O = OPERATION / I = INSTALL

### 1: CHECK H-PLATE / HARNESS / BC FOR WEAR, DAMAGE, OR MISSING PARTS: 7 STEPS

#### A: H-Plate

Look for any bent or broken parts on the H-plate. Verify that the rubber cylinder pads are in place on the cylinder rests. Check the cylinder bands for wear.

#### B: Harness (W)

Check the webbing for excessive wear. Check D-rings, buckle, crotch strap and any diver installed hardware such as knives or equipment pouches are present and in working order.

#### C: Fabric (W)

Lay the BC down flat and inspect the fabric for any tears or signs of excessive wear. Pay special attention to areas around inflator and areas that experience chaffing during use. Never dive the rebreather with a buoyancy compensator that is not in good condition.

#### D: Inflator (O/W)

Depress the inflator and deflater buttons feeling for smooth actuation. If there is any binding or sticking of either button this usually indicates that salt has dried inside the mechanisms. Dried salt can abrade O-rings and cause slow leaks. If you do find that the inflator buttons stick on first actuation, clean with fresh water or repair as needed.

You will complete a pressurized test of the inflator later on in the operational checks. However, it is always a good idea to test each component, but especially important if you find that the buttons have been sticking. Finally, partially inflate the buoyancy compensator by manually blowing air into the valve (*Fig. 2.16*) while depressing the deflater button. Check that the buoyancy compensator is holding air and not leaking. Do not deflate the buoyancy compensator – See step E: Dump Valves.



Fig. 2.16

### E: Dump valve(s) (O, W)

Inspect the buoyancy compensator dump valves. Momentarily open each valve and let a bit of air from the buoyancy compensator out to make sure they open and close freely. Also inspect the air dump pull cords (*Fig. 2.17*) to make sure they are in good condition and not entangled.



Fig. 2.17

### F: Removable weight pockets (W, I) (If Installed)

Verify that you have 2 weight pockets (*Fig. 2.18*). Check that their Velcro flaps, quick-lock and the pull handles in good working condition. Secure them in place.



Fig. 2.18

### G: Fastening clips (W)

Check for broken or cracked parts in the following areas:

- 1.) Waist strap (Buckle)
- 2.) Large counterlung retainer clips attached to waistband (male Fastex) (*Fig. 2.19*)
- 3.) Small lateral counterlung adjusting straps (male Fastex) (*Fig. 2.20*)



Fig. 2.19



Fig. 2.20



**NOTE:** Integrated weight pockets are one of the most frequently lost or left behind pieces of dive gear! Do you know where your weight pockets are?

## 2: INSPECT COUNTERLUNGS: 7 STEPS

### A: Fabric (W)

Lay the counterlungs out and inspect the fabric for tears or obvious signs of abnormal wear. While the counterlungs are quite robust, you must never dive with counterlungs that show signs of excessive wear or damage, as counterlung integrity failure during a dive would cause immediate and catastrophic flooding of the breathing loop. Shake the counterlungs to make sure no foreign objects have entered the counterlung during storage or transportation. Smell the inside of each counterlung. They should not have any distinct odor.

### B: Drains (O) FMCL

Unscrew the locking collar and actuate the valve by depressing the nipple inward toward the body of the valve (*Fig. 2.21*). Blow into the valve to make sure it is not clogged or broken. The valve should pop back out when you let go of the valve. If it does not, it must be replaced. Re-tighten the locking collar.

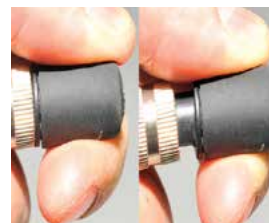

Fig. 2.21

### B: Drain (O) BMCL

Pull on the drain dump cord and make sure the action feels free and while releasing the pull cord, there is a quick and free snap-back of the valve (*Fig. 2.22*). If there is any binding suspected, remove the valve and have it serviced prior to use.



Fig. 2.22



**WARNING. NEVER DIVE WITH A DRAIN THAT IS STICKING, LEAKING OR SHOWS SIGNS OF ABNORMAL WEAR. DOING SO CAN LEAD TO A CATASTROPHIC FLOOD, POSSIBLY LEADING TO SERIOUS INJURY OR DEATH.**

### NOTE: THE SNIFF TEST

Sniff the air inside of the counterlungs. It should smell clean and possibly have a hint of sanitizer smell to it. This is normal when using Hollis approved breathing loop cleaners, however a distinct smell of mold mildew or any other strong odor is not normal and is either due to inadequate sanitizing or not allowing the counterlungs to dry fully before storing.



### C: Threaded DSV assembly rings (FMCL) (W)

Check for cracks and thread stripping. The hose mounting rings (*Fig. 2.23*) are welded to the counterlungs. Make sure the rings are firmly attached to the counterlung fabric.



Fig. 2.23

### C: Threaded T-Piece assembly rings (BMCL) (W)

Check for tightness, cracks or other damage. Clean O-ring mating surface of debris (*Fig. 2.24*).



Fig. 2.24

### D: Breathing hoses, Oetiker clamps & O-rings FMCL/BMCL (W)

Check the counterlung -to- head hoses for holes, wear or age cracking. Stretch the hose slightly and inspect the rubber material. If you can see separation or light spiderweb cracking in the rubber, it is beyond its serviceable life and must be replaced. Never dive with breathing hoses that show signs of rubber aging, as immediate and catastrophic loop flooding will occur if the hoses fail during diving.

Wipe the interior surface of each breathing hose with a clean, dry towel then look at the spot on the towel where you wiped the hose interior. If the towel has foreign particles or dirt on it, re-clean the counterlung and hose using a bottle brush (*Fig. 2.25*) to remove any foreign material in the hose corrugations. See PART 4 Section 2 for further cleaning instructions.



Fig. 2.25

The counterlung -to- head attachment hardware has an O-ring seal (*Fig. 2.26*). Remove, clean and prepare the O-ring(s), O-ring groove and mating surface for use, or replace if worn or damaged. Also at this stage you will want to make sure there is no debris in the hose connection at the head (*Fig. 2.27*). Locate the two hose connections in the head and run your finger inside them. If you feel any debris, clean the inside with a lint-free cloth. If there was any debris on the exhalation side head connector, especially old absorbent particles, some absorbent may have fallen into the head plate area (*Fig. 2.28*), which is located on the underside of the head. Clean out any debris that may have collected in the head plate area prior to unit assembly. If you hear grinding when turning the hose nut, sand or grit has collected between the nut and hose connector. Dip the hose nut and connector in a bucket of water and gently tap the hose nut against the bucket wall to remove the sand.



Fig. 2.26



Fig. 2.27



Fig. 2.28

**E1: FMCL O<sub>2</sub> Addition valve**

Check the oxygen addition valve for tightness by holding the base of the valve from the back of the counterlung through the counterlung fabric and attempt to tighten (twist clockwise) the threaded nut (*Fig. 2.29*). There should be no movement. If the valve has come slightly loose, hand tighten the nut as needed until it will not turn further. Activate the valve button to make sure it operates smoothly. It should not feel stiff or difficult to depress. You will check the valve again for proper operation during your operational checks.



Fig. 2.29

**E2: BMCL Manual O<sub>2</sub> Addition block (O)**

Check that all the fittings are tight, free of rust, sand or other debris. Check the operation of the gas addition button. It should depress freely and spring back without any drag (*Fig. 2.30*).



Fig. 2.30

**F1: Automatic diluent addition valve (ADV) FMCL (O)**

While holding the counterlung, depress the valve body until you feel the plunger move (*Fig. 2.31*). It should move freely. (You will check the valves automatic and manual addition of diluent into the breathing loop during your operational checks.) For a closer inspection, or if you think the valve may be damaged, you can unscrew the valve body from the counterlung by turning the nut counter-clockwise until the valve comes loose from the lung.



Fig. 2.31

**F2: Automatic diluent addition valve (ADV) BMCL (O)**

Check that the cover of the valve body is secure and the swivel is in place and secure (*Fig. 2.32*).



Fig. 2.32

**G: Overpressure valve (OPV) FMCL (O)**

The over-pressure valve is located on the exhale counterlung slightly below the threaded DSV hose opening (*Fig. 2.33*). Rotate the body open and closed. You should feel a slight ratcheting as you twist the body. Rotate the OPV body clockwise until it is fully closed in preparation for the oxygen flush during your operational check.



Fig. 2.33

**G: Overpressure valve/Drain (OPV) BMCL (O)**

The over-pressure valve/Exhalation counterlung drain is located on the inside bottom of the exhale counterlung (*Fig. 2.34*). Pull on the dump cord to insure the valve moves freely and closes without catching. Check the cord to make sure it is not frayed.



Fig. 2.34

### 3: INSPECT DSV BREATHING HOSES: 4 STEPS

#### A: Inhalation & exhalation hoses FMCL/BMCL(W)

While holding the hose by the threaded hose nuts, gently stretch them to insure the ends are secure. If there is any movement, check the hose clamps and hose material next to the clamps (*Fig. 2.35 & 2.36*) for wear or tears.

While continuing to stretch the hose, look along the hose length at the rubber for signs of wear or age cracking. If you see signs of abrasions or spider web cracking, the hose must be replaced. Never dive with breathing hoses that show signs of rubber aging, as immediate and catastrophic loop flooding will occur if a breathing hose tears during diving.

#### B: Oetiker clamps FMCL/BMCL

Check to make sure the clamps are securely locked down onto the hoses (*Fig. 2.37*) and then cover them with the silicone clamp covers so they do not snag fabrics such as wetsuit material while putting on and taking off the rebreather.

#### C: O-Rings FMCL/BMCL(W)

There are two O-rings on each FMCL breathing hose assembly (*Fig. 2.38*). You will find the first O-ring under the counterlung elbow-retaining nut of each hose assembly of the FMCLs. Pull the elbow retaining nut back with your thumb and forefinger and using an O-ring pick, gently remove the O-ring from its groove. Remove, clean and prepare the O-ring(s), O-ring Groove and mating surface for use, or replace if worn or damaged. The BMCLs do not have these O-rings.

As shown in *Fig. 2.39*, the BMCLs have 2 O-rings as well, one under the hosehead retaining nut and one under the DSV counterweight.

The O-ring under the DSV threaded nut counterweight is a bit trickier as you may not be able to fully retract the weighted nut to expose the O-ring. However, you can remove the O-ring with an O-ring pick.

Pull the counterweight nut as far as back from the hose opening as possible. You should be able to see the O-ring. Carefully extract the O-ring from its groove, making sure not to scratch the seating surface. Remove, clean and prepare the O-ring(s), O-ring groove and mating surface for use, or replace if worn or damaged.



Fig. 2.35



Fig. 2.36



Fig. 2.37



Fig. 2.38



Fig. 2.39

To clean the O-ring groove, you can use a Q-tip (*Fig. 2.40*), but be careful not to allow cotton fibers to remain behind. If there are dirt particles on the O-ring when you remove it from the groove, disassemble the threaded counterweight side of the DSV hose assembly by removing the Oe-tiker clamp and thoroughly clean the O-ring groove.

#### **D: Inhalation hose mushroom valve (O, W)**

(only on inhalation hose for DSV supplied systems)

If your PRISM 2 is supplied with a DSV, the inhalation side breathing hose will house a one-way mushroom valve (*Fig 2.41*).

To test the sealing integrity of the valve, place the Inhalation hose on your mouth and put the DSV counterweight in your other hand. While looking at the mushroom valve gently inhale. You should see the mushroom valve seal around the outside surface of the 6-spoke mushroom valve seat (*Fig. 2.42*). You should not feel or hear any air movement from the valve. If you can inhale air, clean the mushroom valve and seat with water. If it continues to leak after cleaning, you must replace the valve (and possibly the valve seat), then repeat the test. If you remove the valve seat for inspection or repair, you must clean and prepare the O-ring(s), O-ring groove and mating surface for use, or replace if worn or damaged.



Fig. 2.40



Fig. 2.41



Fig. 2.42

## 4: INSPECT DSV 5 STEPS

### A: Shut-Down/OC assembly (O)

Open and close the DSV to make sure the inner barrel operates smoothly and does not bind. If it is hard to open or close, or if you hear a scraping sound during barrel movement, the DSV barrel and housing will need to be cleaned and lubricated.

DSV: There are three sealing O-rings on the DSV rotating barrel (*Fig. 2.43*). You will be checking the sealing of these during your positive and negative pressure tests. If any of these O-rings should fail, you will need to service the DSV.



Fig. 2.43

### B: Water drain (O)

On the underside of the DSV you will see a small hole just under the mouthpiece (*Fig. 2.44*). This is the water drain hole. Check to make sure it is not clogged.

Place the DSV in your mouth with the valve closed and blow into the mouthpiece. You should be able to blow air through the drain hole, but you will feel some back-pressure. If you cannot blow air through the drain hole, debris may have clogged the hole or become lodged in the drain channel in the rotating stainless steel sleeve. You will need to service the DSV.



Fig. 2.44

### C: Mouthpiece, zip-tie

Check for holes or torn bite tabs in the mouthpiece. Replace as needed. Check that the zip-tie retainer is present and holding the mouthpiece securely onto the DSV

**D: DSV exhalation mushroom valve (O, W)**

Open the DSV to the CC position. Place your palm over the left side opening of the DSV fully blocking it, and attempt to gently draw air in. There should be no air movement. If you are able to draw air in, clean the exhalation mushroom valve and seat with water. If it continues to leak after cleaning, you must replace the exhalation side mushroom valve and seat, then repeat the test.

**5: INSPECT REGULATORS + HOSES: 6 STEPS****A: 1st stages (W)**

Remove the cap on the first stage EN144-3/ ISO 12209 valve and inspect the EN144-3/ ISO 12209 fitting for signs of previous water ingress such as discoloration or salt buildup (*Fig. 2.45*) on the filter surface. If there are signs of water ingress, do not dive the unit until the first stage, hoses and pressure gauges attached to it have been serviced by a Hollis authorized repair facility. Failure to properly maintain the first stages could result in a free-flow of gas into the breathing loop and lead to serious injury or death. Verify that the EN144-3/ ISO 12209 valve's cylinder O-ring is in place and clean. Replace it if there are any signs of wear.



Fig. 2.45

**B: Pressure relief valves**

Check that the pressure relief valve (*Fig. 2.46*) is in place and the body of the valve has not sustained any impact damage. You will verify that the valve is sealed when you pressurize the first stage. Should the valve activate and discharge gas, suspect a malfunctioning first stage. You can verify if the intermediate pressure is outside of operating parameters with an in-line pressure gauge outfitted with a low pressure QD fitting.



Fig. 2.46

### **C: LP (Low Pressure) hoses & connectors (W)**

Check each hose leading from the first stages for signs of wear or age. Replace as necessary only with Hollis approved parts. Check all LP quick disconnect hardware for corrosion and verify that the Schrader valve is clean of debris, salt or corrosion. If the QD fittings are becoming stiff or are built-up with corrosion, a 1/2 hour soak in white vinegar may remove the build-up.



**WARNING: IT IS IMPORTANT TO UNDERSTAND THAT ALL OF THE LP OXYGEN SUPPLY HOSES CONTAIN IN-LINE FLOW RESTRICTORS, AND MUST NEVER GET EXPOSED TO SALT WATER. NEVER REPLACE AN O<sub>2</sub> SIDE LOW OR HIGH-PRESSURE HOSE WITH ANYTHING OTHER THAN THE CORRECT HOLLIS PART.**



**WARNING: IT IS IMPORTANT TO NOT CONNECT A 2ND STAGE REGULATOR OR BOV (BAIL-OUT VALVE) TO THE PRISM 2 FIRST STAGE. THIS FIRST STAGE IS NOT EN250:2014 APPROVED.**

### **D: HP (High Pressure) hoses & connectors (W)**

Check each HP hose leading from the first stages for signs of wear. Replace as necessary only with Hollis approved parts.

### **E: Diver installed gas supply hoses (if present) (W)**

If any other gas supply hoses are attached to the diluent first stage such as a drysuit hose or second stage, check them for signs of wear. Replace as needed.

### **F: Pressure gauges (O, W)**

Look at both pressure gauges and verify that the needle is resting at 0 psi / 0 bar. If it is not, have the pressure gauge repaired or replaced. Unless there are obvious signs of impact damage to the faulty gauge, suspect water ingress through the first stage and have the rebreather gas supply system serviced by an authorized Hollis repair facility. It is especially important for the Oxygen side of the system to remain free from contamination, as all parts must remain oxygen clean. (Refer to the User Service Guide for further information).

## **6: INSPECT WIRING: 2 STEPS**

### **A: HUD (Heads Up Display) (W)**

Check the Heads Up Display and wiring for damage. Turn the unit power on and verify that all three of the LED's (Fig. 2.47) illuminate red then green, once. If all three lights illuminate continuously orange for 30 seconds, the Heads Up Display battery must be changed. Once checked, turn off the HUD. (See the HUD light states section of the PRISM 2 Displays and Electronics User Manual for display explanations.)



Fig. 2.47



## B: Wrist Display (W)

Inspect Wrist Display and wiring for wear or damage. Turn on the Wrist Display by depressing both the menu and select buttons (*Fig. 2.48*). After the splash screen, the system will switch to the main information screen.

## 7: BATTERY COMPARTMENT, BATTERIES + O-RINGS: 4 STEPS (W)

### A: Solenoid batteries

The solenoid runs on two 9V alkaline (Duracell® or equivalent quality only) batteries wired in parallel and located in the battery compartment of the electronics housing (*Fig. 2.49*). To check the solenoid voltage, you will first need to make the wrist unit fire the solenoid at least once. The easiest way to do this is switch the setpoint to one that has a higher PO<sub>2</sub> than ambient air.

If all readings on the wrist unit read “FAIL” you will need to calibrate the wrist unit before it will fire the solenoid, see note below. With the wrist display turned on from the previous step, depress the select button six times until you see the bottom of the screen display the voltages for the external battery (solenoid) and the internal battery (wrist display) (*Fig. 2.50*). A voltage above 7V, as reported by the Wrist Display, is considered by the electronics as acceptable. Therefore no dive should be conducted unless the voltage reported by the Wrist Display is greater than 7V. If the voltage is reported at or below 7V then both batteries must be changed prior to conducting a dive.



Fig. 2.48



Fig. 2.49

<u>EXT V</u>	<u>INT V</u>
8.8	3.4

Fig. 2.50

The computer measures the dynamic voltage of the solenoid batteries, which means the voltage is being measured while the solenoid is firing and the batteries are under load. This is the most accurate way to verify the actual working capacity of the batteries. Using a voltmeter that does not put a load on the battery can give you a higher voltage reading, but the measurement will not be nearly as accurate a gauge of actual battery capacity. This is why we do not recommend relying on a voltmeter to test the solenoid batteries.



### NOTE: Solenoid Battery

For the computer to measure the dynamic load of the solenoid battery, the PRISM 2 must have a valid calibration stored in memory to allow the solenoid to fire. If, when you turn on the Wrist Display, all three sensors display “fail”, the solenoid will not fire and the voltage display for the solenoid battery will show “?”. You will not be able to verify the dynamic voltage of the solenoid batteries until the system has been calibrated, which will then allow the solenoid to fire.

### B: HUD (Heads Up Display) battery

The HUD battery is located in the battery compartment. It is a SAFT 3.6V AA battery.

### C: O-Rings (2) (W)

There are two O-rings sealing the battery compartment. A “compression seal” O-ring sits inside the O-ring groove at the top of the battery compartment (*Fig. 2.51*), and its mating face is the underside edge of the battery cap. Remove, clean and prepare the O-ring(s), O-ring groove and mating surface for use, or replace if worn or damaged.

The second “Radial seal” O-ring resides in a groove on the inside edge of the battery cap (*Fig. 2.52*), and its mating edge is the inside surface of the electronics stack. Remove, clean and prepare the O-ring(s), O-ring groove and mating surface for use, or replace if worn or damaged.

### D: Cover, cover latches & keepers (O, W)

The aluminum battery cap is held in place by two Nielsen Sessions stain-less steel locking latches (*Fig. 2.53*). Operate the latches and check that they are free of debris, and the locking mechanism locks firmly into place. Damaged latches must be replaced before immersing the PRISM 2 in water.

Failure to keep the battery compartment latches in working order can result in flooding of the battery compartment.

The latch keepers are molded into the battery compartment cap. Make sure there is no impact damage which could have cracked the aluminum keepers.



Fig. 2.51



Fig. 2.52



Fig. 2.53



**WARNING: THE BATTERY CAP IS EQUIPPED WITH A PRESSURE RELIEF VALVE. IF THE BATTERY COMPARTMENT WERE TO FLOOD, BATTERY ACID AND POISONOUS GASES WILL FORM INSIDE THE COMPARTMENT. YOU MUST NEVER EXPOSE YOURSELF TO EITHER THE ACID OR GASES FROM THE VENTING BATTERY COMPARTMENT.**



**WARNING: SHOULD THE COMPARTMENT FLOOD DURING DIVING OPERATIONS, THE PRESSURE RELIEF VALVE WILL VENT THE PRESSURIZED GASES AND ACID INTO THE SURROUNDING WATER.**



**WARNING: BECAUSE THE SOLENOID AND HEADS UP DISPLAY BATTERIES ARE IN THIS COMPARTMENT, IF THE COMPARTMENT FLOODS, THE BATTERIES WILL QUICKLY LOSE THEIR CHARGE CAUSING THE HEADS UP DISPLAY AND SOLENOID WILL STOP WORKING.**



**CAUTION: AFTER A BATTERY COMPARTMENT FLOOD, YOU MUST TAKE PRECAUTIONS WHILE CLEANING AND DISPOSING OF ALL MATERIALS WITHIN THE COMPARTMENT, AND MUST NOT DIVE AGAIN UNTIL YOU HAVE REPLACED THE BATTERY CAP PRESSURE RELIEF VALVE. (SEE THE USER SERVICE GUIDE FOR FURTHER INFORMATION ON RECOVERING FROM A FLOODED BATTERY COMPARTMENT.)**

## 8: SOLENOID OPERATION (O,W)

**(If you are proceeding immediately to assembly and operational checks, you can skip this step.)**

While you will be verifying the operation of the solenoid with the operational checks, it is always a good idea to verify its operation at this stage if you will be traveling away from immediate repair support.

To check the solenoid operation now, you will need to hook up the oxygen side 1st stage, solenoid supply hose and a pressurized oxygen cylinder to the solenoid and power up the PRISM 2 to check that the solenoid is firing and adding O<sub>2</sub> to the breathing loop.

Install the oxygen supply hose onto the solenoid. Install an oxygen cylinder onto the oxygen side first stage. This is temporary and you will be removing the O<sub>2</sub> cylinder after this test, so you can leave the cylinder on loosely (*Fig. 2.54*). Slowly open the O<sub>2</sub> cylinder valve to charge the lines, then close the valve.

Turn on the Wrist Display and change the setpoint to either low or high setpoint. Listen for the solenoid firing and watch the oxygen pressure gauge. You should see the pressure in the lines drop as oxygen is injected into the head. Allow the solenoid to continue firing until the pressures in the lines are drained. Remove the O<sub>2</sub> first stage from the cylinder valve and the supply hose from the solenoid.

If you can hear the solenoid click, but the pressure in the lines does not decrease as shown on the pressure gauge, most likely you have a clogged flow restrictor. If the solenoid does not fire, make sure you have selected an active setpoint above ambient air. Remember, if all 3 cell outputs read “fail”, there is no valid calibration stored in memory and the solenoid will not fire regardless of the active setpoint. If all the O<sub>2</sub> sensor readings on the wrist unit show “fail”, you will need to calibrate the unit prior to verifying solenoid operation. If the Wrist Display does show readings for the O<sub>2</sub> cells and the battery display shows charged batteries, it may be that water has gotten into the oxygen first stage and hoses, or the solenoid has simply failed. Have the unit serviced by an authorized Hollis service center. Never dive your PRISM 2 with a failed solenoid.



Fig. 2.54

## 9: INSPECT HEAD ASSEMBLY: 5 STEPS

### A: Red CO<sub>2</sub> Seal (I, W)

The Red CO<sub>2</sub> Seal is a thick, spongy-feeling red gasket that resides on the underside of the head in a channel on the face of the head plate adjacent to the three O<sub>2</sub> sensors (*Fig. 2.55*).



#### **WARNING: DO NOT LUBRICATE THE RED CO<sub>2</sub> SEAL.**

The Red CO<sub>2</sub> Seal **MUST** be checked now and prior to sealing the bucket to the head. The Red CO<sub>2</sub> Seal is a critical component of a properly functioning breathing loop. If the seal were left out during operation (*Fig. 2.56*), you would have 100% CO<sub>2</sub> breakthrough, possibly leading to injury or death.



#### **WARNING: YOU MUST VERIFY THAT THE RED CO<sub>2</sub> SEAL IS IN PLACE, SEATED PROPERLY IN ITS GROOVE AND IS CLEAN AND UNDAMAGED ANYTIME YOU LOAD THE CO<sub>2</sub> SCRUBBER BASKET INTO THE UNIT. FAILURE TO CHECK THE RED CO<sub>2</sub> SEAL MAY LEAD TO SERIOUS INJURY OR DEATH.**

### B: Head to bucket O-rings (2) (W, I)

The head to bucket sealing flange (*Fig. 2.57*) incorporates two bucket sealing O-rings. You must check clean, and lubricate both O-rings and their seating surfaces whenever the bucket has been removed from the seating flange. To begin the cleaning process, remove the two O-rings from their grooves starting with the O-ring closest to the head (#1) (*Fig. 2.58*) and lay it on a clean towel. Next, remove the O-ring closest to the edge of the bucket flange (#2) (*Fig. 2.59*).

Never use any sharp or metal objects to remove the O-rings, as that would damage the O-ring and/or the seating surface. Never over-stretch the O-rings while removing them.



**NOTE:** Remove the O-rings in the order stated in the text to keep you from having to drag an O-ring across an empty O-ring groove, which can result in nicked, stretched or broken O-rings.

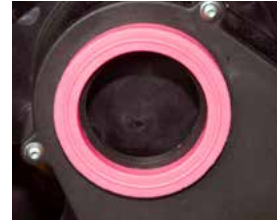

Fig. 2.55



Fig. 2.56



Fig. 2.57



Fig. 2.58



Fig. 2.59

Clean any debris (usually small particles of soda lime) and lubricant on the O-rings with a lint-free towel. Once clean, run the O-rings through your fingers feeling for any nicks or left over debris while visually inspecting them at the same time. There must be no lint, hair, or particles of any kind on the cleaned O-ring, since debris on the O-ring would cause a seal failure. If you find any damage to the O-ring, it must be replaced with a new O-ring from your spares kit.

Lay the two cleaned, but not yet lubricated O-rings aside on a clean surface. Clean the seating surface on the head flange, making sure to remove any debris that may have collected in the O-ring grooves.

### **C: O-ring seats**

Use a clean lint-free cloth or Q-tip and clean old lubricant and absorbent from the two O-ring channels. It may be difficult to clean the portion of the channel facing the H-plate when the Head is mounted into the H-plate.

Put a small dab of lubricant on your forefinger and lightly coat each O-ring with a sheen of lubricant by running the O-ring between your forefinger and thumb. While you are doing this, feel for any leftover debris and if found, re-clean the O-ring and reapply fresh lubricant.

Immediately replace all cleaned and lubricant-treated O-rings onto the head after you lube them, in the opposite order in which you took them off.

To re-install the O-rings, start by putting the first O-ring in the bottom groove (#2) on the head. This will make putting the subsequent O-ring in place easier by not having to work the O-ring past an empty groove.

Once the head to bucket sealing surface has been cleaned and the treated O-rings are in place on the flange, it is recommended that you temporarily replace the bucket on the head. This will keep debris off the cleaned surfaces until you are ready to mount the absorbent-filled basket assembly on the head in preparation for diving.



**NOTE:** Never lay a lubricated O-ring down, even on a seemingly clean surface. The lubricant will pick up an amazing amount of surrounding debris that your eyes didn't see.

#### D: Bucket latch keeper (W, O)

The bucket latch keeper is a stainless steel channel that runs around the face of the head and is screwed into place. Verify that the 4 screws are in place and the seat is not loose (Fig. 2.60). If the seat were to fail during a dive, the Velcro bucket strap would most likely keep the bucket firmly seated on the head, however with a failed latch keeper, a catastrophic flood could result.



Fig. 2.60



**WARNING: ALL SCREWS THAT SECURE THE BUCKET LATCH KEEPER ONTO THE HEAD MUST BE IN PLACE AND IN GOOD CONDITION. NEVER DIVE THE UNIT IF ANY RETAINING SCREWS ARE MISSING OR DAMAGED. NEVER REPLACE THE SCREWS WITH NON-APPROVED HARDWARE. DOING SO COULD CAUSE THE LATCH SEAT TO FAIL AND THE UNIT TO EXPERIENCE AN IMMEDIATE AND CATASTROPHIC FLOOD, POSSIBLY LEADING TO INJURY OR DEATH.**

#### E: Nut Bars, Head Bolts, Head Cover Bar, and Head Cover

Verify that the Nut Bars and Head Bolts are in place. Check that the Head Cover Bar is not bent. Verify that the Head Cover latch is working and there are no impact cracks on the cover.

### 10: OXYGEN SENSORS: 3 STEPS

#### A: 3 Oxygen sensors & sensor holders installed (I)

The three oxygen sensors are mounted on the underside of the head in removable, vibration resistant cell holders (Fig. 2.61). Each cell holder is held in place by two pins. Make sure all three-cell holders are firmly seated on the pins and are in good condition. You should never allow any lubricant to get on the sensor housings or the sensor holders, as that could allow the sensor to slide out of the holder during a minor transit impact, thereby damaging the sensor. If there is grease on the sensor housing or holder, gently clean both with a mild surfactant cleaner such as Crystal Simple Green™. Do not attempt to clean this area with the O<sub>2</sub> sensors in place. Remove the sensors prior to cleaning. (See the list of approved cleaning agents in PART 5 Section 2).



Fig. 2.61

### B: Oxygen sensor wiring harness (W)

The O<sub>2</sub> sensor-wiring harness has one locking 6 pin Molex connector (*Fig. 2.62*), which connects into the head and three locking 3 pin (2 wire) Molex connectors that go to each sensor. The connectors are the high pressure 4 sided pin capture style. The wiring is silver-coated copper stranded wire. Operationally it does not matter which 3 pin connector goes to which O sensor as they are mounted in the head, but for diagnostic purposes, the connectors are numbered and the wiring color designation is as follows:

COLOR	O <sub>2</sub> READOUT ON WRIST DISPLAY AND HUD
RED & BLK =	# 1
WHT & BLK =	# 2
BLU & BLK =	# 3

### C: mV readings within range (O) (8.5 mV to 14 mV in air)

The Analytical Industries Hollis (PRISM 2) PSR11-39-MD O<sub>2</sub> sensor voltage output should be between 8.5 and 14 mV in air, and 40 to 67 mV at sea level in 100% oxygen (the valid mV reading (as far as the computer is concerned) for 98% O<sub>2</sub> calibration is 30-70 mV). On the wrist display, switch the display to the sensor's mV readings and verify that the sensors are in range for the gas to which they are exposed.

From the main screen, depress the select button until the cell readouts display their millivolt readings (*Fig. 2.63*).

## 11: BUCKET ASSEMBLY: 3 STEPS

The scrubber bucket is made from high density, high-pressure injection-molded clear urethane (*Fig. 2.64*). It is an extremely rugged, durable and strong material which also helps thermally protect the scrubber material by creating an insulating gas space around the scrubber. Because high pressure Urethane is a very poor thermal conductor compared to other commonly used materials, such as aluminum or stainless steel, it also acts to preserve the heat needed for efficient CO<sub>2</sub> sequestration.



Fig. 2.62

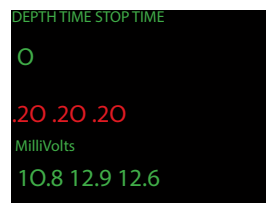

Fig. 2.63



Fig. 2.64



### A: Basket compression spring & pad (I)

The scrubber basket compression spring (*Fig. 2.65*) sits on a retaining post that is molded into the bottom of the scrubber bucket. The spring is designed to keep the inhalation tube area of the scrubber basket firmly sealed on the red Red CO<sub>2</sub> Seal, which is mounted on the head plate in the head.



Fig. 2.65

Confirm that the spring pad and locking nut are in place and that the spring compresses by pushing down on it. Ensure as well that the nylock nut holding the spring pad onto the post and spring has one thread exposed.

### B: Latches (W, O)

There are three Nielson Sessions stainless steel hinged latches (*Fig. 2.66*) mounted on the stainless steel band toward the top of the bucket. Operate the latches and check that they are free of debris, rust, or excessive wear. Verify that the locking mechanisms lock firmly into place.



Fig. 2.66



**WARNING: DAMAGED OR WORN LATCHES MUST BE REPLACED BEFORE IMMERSING THE PRISM 2 IN WATER OR COMMENCING DIVING OPERATIONS. FAILURE TO VERIFY THAT THE SCRUBBER BUCKET LATCHES ARE IN GOOD WORKING ORDER, OR DIVING WITH BROKEN OR WORN LATCHES CAN RESULT IN A CATASTROPHIC FLOODING OF THE LOOP, POSSIBLY LEADING TO SERIOUS INJURY OR DEATH.**

### C: 1 Moisture pad (I)

Check that you have a bucket moisture pad installed at the bottom of the bucket. The moisture pad should be capable of absorbing the majority of condensation moisture that collects along the bucket wall, which drips to the bottom of the bucket during use.



**WARNING: YOU MUST USE ONLY HOLLIS APPROVED BUCKET MOISTURE PADS. NEVER USE A MOISTURE PAD THAT CAN INTERFERE WITH THE COMPRESSION SPRING AND CLEARANCES OF THE SCRUBBER BASKET. USING MOISTURE PADS THAT WERE NOT DESIGNED FOR THE HOLLIS PRISM 2 COULD INTRODUCE HARMFUL CHEMICALS INTO THE BREATHING LOOP, DAMAGE THE BASKET, BUCKET SPRING, BUCKET LATCHES, RED CO<sub>2</sub> SEAL OR LATCH SEAT. A FAILURE IN ANY OF THESE AREAS DURING DIVING OPERATIONS COULD LEAD TO SERIOUS INJURY OR DEATH.**

## 12: BASKET ASSEMBLY (W): 4 STEPS

The basket assembly comes in four basic parts (Fig. 2.67): the basket, the basket lid, the center tube and the center tube O-ring. The basket assembly utilizes a strong nylon mesh to avoid rips and is also somewhat elastic so it will not create dust by abrading the absorbent along its walls during packing, transit or handling. The nylon mesh is also thermally non-conductive which helps keep the absorbent material as thermally efficient as possible.



Fig. 2.67

### A: Check mesh (W)

Look at the mesh of both the basket and the center tube. There must not be obvious tears or abrasions of the mesh. Do not attempt to repair a basket with torn or abraded mesh, as any material or repair failure during diving operations would cause the absorbent to spill out of the basket, resulting in an instant and catastrophic CO<sub>2</sub> bypass.

### B: Center tube O-ring (I)

The center tube screws into the basket base and is sealed with an O-ring. You do not normally have to remove the center tube for cleaning, but if you do, remove, clean the O-ring, its groove and mating surface for use, or replace if worn or damaged. It is neither necessary or advisable to lubricate the center tube O-ring. It would only serve to collect dust, and there is no pressure differential on either side of the O-ring.

### C: Top + basket threads clean (O)

Keeping the scrubber clean is very simple, but one of the problems between cleaning is crushed absorbent dust caking up in the scrubber basket threads (Fig. 2.68). The more humid the environment in which you are packing your absorbent basket, the more you will find the material is building up in the threads. While not a safety concern in and of itself, caked-on absorbent can make it more difficult to screw down the top of the basket, which can be a safety concern if the basket top is not fully engaged onto the threads. Prevent crushing absorbent into the threads by keeping the absorbent material away from the edges when placing material at the top of the basket.



Fig. 2.68



**WARNING: NEVER ATTEMPT TO REPAIR OR DIVE A SCRUBBER BASKET THAT HAS TORN MESH. DOING SO COULD LEAD TO INJURY OR DEATH.**

The easiest way to remove absorbent that has built up in the threads is to soak the top and basket threads in white vinegar for 10 to 15 minutes. If time is an issue, heat the vinegar to 100 °F/38 °C, and soak the parts. Rinse thoroughly and dry the basket before re-packing it.

### D: Top + bottom foam pads (I)

The foam pad with the larger diameter center hole is placed on the bottom of the basket prior to filling (Fig. 2.69). The pad, with the smaller hole, goes on top of the absorbent filled basket, under the basket cap. Both the bottom and top pads are used to impede any laminar flow of gas which might occur along the smooth surfaces of the basket top and bottom.



Fig. 2.69



**WARNING: THE FOAM PADS MUST BE USED TO IMPEDE LAMINAR GAS FLOW AND CO<sub>2</sub> BREAKTHROUGH.**

After many uses and cleanings, the foam pads will become thin and start to deteriorate. At that point you should replace the pads with new ones.



**WARNING: YOU MUST ENSURE THAT YOU REPLACE THE CENTER TUBE O-RING DURING ASSEMBLY. FAILURE TO DO SO COULD ALLOW SOME GAS TO CHANNEL THROUGH THE TOP OF THE SCRUBBER. IF YOU USE A DULL SCRAPING TOOL TO REMOVE CAKED-ON ABSORBENT FROM THE BASKET TOP THREADS, BE VERY CAREFUL! IT IS VERY EASY FOR THE TOOL TO ACCIDENTALLY SLIP ON THE THREADS AND TEAR THE MESH, YOUR SKIN, OR BOTH.**

# PRISM 2

# Assembly

The following section details the assembly steps to assemble a fully functioning Prism 2. Please note that sections which detail steps applicable to all builds (FMCL & BMCL equipped Prism 2s) will not have a build specific header at the top of the page.

Sections which apply to ONLY Front-Mounted Counterlung assembly steps will have the following header at the top of the page:

FMCL

Sections which detail ONLY Back-Mounted Counterlung assembly steps will have the following header at the top of the page:

BMCL

Items which detail ONLY DSV assembly steps will show the step descriptor with “DSV” in bold

# PRISM 2 ASSEMBLY

Now that you are intimately familiar with the intricacies of every part that makes up an operational Prism 2, we will begin the Assembly process by mating the only 3 parts of the rebreather that require one-time assembly with tools.

When you first unpacked your Prism 2, the “Head” of the Rebreather was packed separately in a sturdy box for safety and was not mounted to the H-Plate. Before System Assembly can begin, you will need to attach the Nut Bar to the Mounting Tube which comprise the sub-assembly which secures the Head onto the H-Plate.

## INSTALLING THE HEAD ASSEMBLY ONTO H-PLATE: 2 STEPS

### Step1: Install the Nut bar and mounting tube onto the head.

1. Insert a Nut Bar onto the Mounting Tube as shown in (Fig. 2.70) and using a crescent wrench or 3/8” box wrench and a Phillips Head screwdriver, ensure the “ears” of the Nut Bar are facing in and run the screw through the hole in the Nut Bar and mounting tube. Secure the screw using the nylock nut.
2. With the one Nut bar secured to the mounting tube, place the nut bar into the head area as shown in Fig. 2.71 Make sure the mounting tube sits over the battery cover.
3. Slide the other Nut Bar over the other side of the mounting tube as shown in Fig. 2.72.
4. Rotate the Nut bar so the “ears” slide into position in the head. Fig. 2.73
5. Run the screw through the hole in the Nut Bar and mounting tube. Secure the screw using the nylock nut. Fig 2.74

### Step2: Install the Head onto the H-Plate.

6. Identify the 4 mounting holes on the H-Plate and place the H-Plate onto the flat flange surface on the head where the Nut Bars are. Take the 4 Nylon set screws and place them in the holes. Hand tighten two screws then tighten them using a 5/16ths Allen wrench. Do not tighten them fully at this point.



**CAUTION: YOU DO NOT NEED TO USE MUCH FORCE ON THE NYLON ALLEN SCREWS TO KEEP THEM IN PLACE. USE ONLY ENOUGH TORQUE TO FULLY SEAT THE H-PLATE ONTO THE HEAD. USING TOO MUCH FORCE WILL STRIP OR BREAK THE ALLEN SCREWS.**

7. The opposing 2 Nylon screws may easily find the Nut Bar threads or you may need to use a flat head screwdriver to persuade the nut bar into proper position. Once you have started the threads, tighten down the screws fully. Go back to the other side and tighten them fully. Fig 2.75



Fig. 2.70



Fig. 2.71



Fig. 2.72



Fig. 2.73



Fig. 2.74



Fig. 2.75

## FMCL ASSEMBLY ORDER CHECKLIST

**1. Fill scrubber basket with CO<sub>2</sub> absorbent + store in airtight container.**

**Label Container: Date Packed, Grade, Time Used, Time Left, User**

Date Packed: \_\_\_\_\_ Grade: \_\_\_\_\_ Time Used: \_\_\_\_\_ Time Left: \_\_\_\_\_ User: \_\_\_\_\_

Maximum Scrubber Duration: (EN 14143 conforming testing)

- 190 min (0.5%, SEV CO<sub>2</sub>) using 8-12 @ 40 °F/4 °C, 1.6 L/min CO<sub>2</sub>, 131 fsw/40 msw
- 215 min (0.5%, SEV CO<sub>2</sub>) using 8-12 @ 40 °F/4 °C, 1.6 L/min CO<sub>2</sub>, 330 fsw/100 msw
- 190 min (0.5%, SEV CO<sub>2</sub>) using 8-12 @ 40 °F/4 °C, 1.6 L/min CO<sub>2</sub>, 18 fsw/6 msw

**2. Fill O<sub>2</sub> & Diluent cylinders, analyze contents, label cylinders with name, date, contents.**

O<sub>2</sub>%: \_\_\_\_\_ Pressure: \_\_\_\_\_ psi/bar Dil Contents: \_\_\_\_\_ Pressure: \_\_\_\_\_ psi/bar MOD: \_\_\_\_\_

**3. Install Regulators + Hoses on H-Plate**

- A. O<sub>2</sub> system on right (head facing up) - run all lines under bottom cylinder straps.

**4. Install BCD, Yoke + Backplate Onto H-plate**

- A. Long screw on top, short screw on bottom - secure with nylon keepers.
- B. Install BCD on plate - inflator facing H-Plate.
- C. Install yoke harness - Fastex clips facing BCD.
- D. Install the counterlung pull down straps
- E. Install the counterlung side straps to the back- plate
- F. Install backplate and harness – place on washers and tighten butterfly nuts.

**5. Attach Counterlungs To Yoke**

- A. Insure inhale counterlung is on right side (with bladder & yoke face-up).
- B. Clip Fastex buckles in place
- C. Line-up Velcro parts and compress

**6. Install Counterlung Breathing Hoses To Head**

- A. Clean and lubricate O-rings, O-ring grooves and mating surfaces.
- B. Install hose nuts finger tight. Do not over-tighten.

**7. Attach Gas Supply Lines To Diluent + Oxygen Addition Valves On Counterlungs + BCD Inflator**

- A. Attach all 3 QD fittings. Pull on hoses to make sure they are secure.

**8. Assemble DSV + Hoses, Check + Install**

- A. Open/close, purge, mouthpiece
- B. Check mushroom valve seals and flow direction.
- C. Install hoses onto DSV
- D. Perform a mushroom valve sealing test (stereo check)
- E. Install DSV onto counterlungs paying attention to flow direction arrow.
- F. Install LED Heads Up Display holder fix/attach cable to breathing hose.

**9. Clean Head To Bucket Sealing Rings, O-Ring Grooves + Lube O-Rings**

- A. Remove O-rings per manual instructions, clean + replace if needed.

**10. Clean Red CO<sub>2</sub> Seal + Secure In Place**

- A. Make sure there is no debris, dust or lubricant. Clean seal groove.
- B. Make sure the red CO<sub>2</sub> seal is firmly seated in its groove (triple check!)

**11. Check Filled CO<sub>2</sub> Scrubber Basket**

**12. Check Scrubber Bucket**

- A. Ensure bucket sealing surface is clean
- B. Basket compression spring installed + functional
- C. Install bucket moisture pads
- D. Make sure the pad is not resting on or interfering with the basket compression spring

**13. Place CO<sub>2</sub> Basket In Bucket, Confirm Center Tube Opening Up, Mount + Seal Bucket To Head (record usage time on operational checklist)**

**14. Mount cylinders to H-Plate & thread 1st stages into valves**

## BMCL ASSEMBLY ORDER CHECKLIST

**1. Fill scrubber basket with CO<sub>2</sub> adsorbent + store in airtight container.**

**Label Container: Date Packed, Grade, Time Used, Time Left, User**

Date Packed: \_\_\_\_\_ Grade: \_\_\_\_\_ Time Used: \_\_\_\_\_ Time Left: \_\_\_\_\_ User: \_\_\_\_\_

Maximum Scrubber Duration: (EN 14143 conforming testing)

- 190 min (0.5%, SEV CO<sub>2</sub>) using 8-12 @ 40 °F/4 °C, 1.6 L/min CO<sub>2</sub>, 131 fsw/40 msw
- 215 min (0.5%, SEV CO<sub>2</sub>) using 8-12 @ 40 °F/4 °C, 1.6 L/min CO<sub>2</sub>, 330 fsw/100 msw
- 190 min (0.5%, SEV CO<sub>2</sub>) using 8-12 @ 40 °F/4 °C, 1.6 L/min CO<sub>2</sub>, 18 fsw/6 msw

**2. Fill O<sub>2</sub> & Diluent cylinders, analyze contents, label cylinders with name, date, contents.**

O<sub>2</sub>%: \_\_\_\_\_ Pressure: \_\_\_\_\_ psi/bar Dil Contents: \_\_\_\_\_ Pressure: \_\_\_\_\_ psi/bar MOD: \_\_\_\_\_

**3. Install Regulators + Hoses on H-Plate**

- A. O<sub>2</sub> system on right (head facing up) - run all lines under bottom cylinder straps.
- B. Attach Solenoid supply hose

**4. Install BCD, BMCL + Backplate Onto H-plate**

- A. Long screw on top, short screw on bottom - secure with nylon keepers.
- B. Install BCD on plate - inflator facing H-Plate.
- C. Pull gas supply hoses thru cylinder band notches in BCD
- D. Install BMCL - T-Pieces facing BCD.
- E. Install backplate and harness – place on washers and tighten butterfly nuts.

**5. Attach Counterlungs To Harness**

- A. Fold the T-Pieces over onto the harness and secure velcro tabs on the inhale and exhale sides onto the harness

**6. Install T-Piece Breathing Hoses To Head**

- A. Clean and lubricate O-rings, O-ring grooves and mating surfaces.
- B. Install hose nuts finger tight. Inhalation side nut is white indicating counter-clockwise threads. Do not over-tighten.

**7. Attach Gas Supply Lines To Diluent + Oxygen Addition Blocks, ADV + BCD Inflator**

- A. Attach O<sub>2</sub> supply hose QD to Manual Addition Block
- B. Attach ADV supply hose (screw-on fitting)
- C. Attach Diluent supply hose QD to Manual Addition Block
- D. Attach BCD Inflation QD

**8. Assemble DSV + Hoses, Check + Install**

- A. Open/close, purge, mouthpiece
- B. Check mushroom valve seals and flow direction.
- C. Install hoses onto DSV
- D. Install LED Heads Up Display holder fix/attach cable to breathing hose.

**9. Clean Head To Bucket Sealing Rings, O-Ring Grooves + Lube O-Rings**

- A. Remove O-rings per manual instructions, clean + replace if needed.

**P - Clean Red CO<sub>2</sub> Seal + Secure In Place**

- A. Make sure there is no debris, dust or lubricant. Clean seal groove.
- B. Make sure the red CO<sub>2</sub> seal is firmly seated in its groove (triple check!)

**Q - Check Filled CO<sub>2</sub> Scrubber Basket**

- A. Basket top secure
- B. Check for settling and firmness of absorbent bed

**R - Check Scrubber Bucket**

- A. Ensure bucket sealing surface is clean
- B. Basket compression spring installed + functional
- C. Install bucket moisture pads
- D. Make sure the pad is not resting on or interfering with the basket compression spring

**S - Place CO<sub>2</sub> Basket In Bucket, Confirm Center Tube Opening Up, Mount + Seal Bucket To Head (record usage time on operational checklist)**

**T - Mount cylinders to H-Plate & thread 1st stages into valves**



## ASSEMBLY ORDER CHECKLIST: DETAILS

### 1: FILL SCRUBBER BASKET WITH CO<sub>2</sub> ABSORBENT & STORE IN AN AIRTIGHT CONTAINER. LABEL CONTAINER: DATE FILLED, GRADE, TIME USED TIME LEFT.

Date Packed: \_\_\_\_\_ Grade: \_\_\_\_\_ Time Used: \_\_\_\_\_ Time Left: \_\_\_\_\_

#### **Maximum Scrubber Duration:** (EN 14143 conforming testing)

- 190 min (0.5%, SEV CO<sub>2</sub>) using 8-12 @ 40 °F/4 °C, 1.6 L/min CO<sub>2</sub>, 131 fsw/40 msw
- 215 min (0.5%, SEV CO<sub>2</sub>) using 8-12 @ 40 °F/4 °C, 1.6 L/min CO<sub>2</sub>, 330 fsw/100 msw
- 190 min (0.5%, SEV CO<sub>2</sub>) using 8-12 @ 40 °F/4 °C, 1.6 L/min CO<sub>2</sub>, 18 fsw/6 msw

Fill the scrubber basket in accordance with the directions in PART 2 Section 2. Record the date you packed the scrubber, confirm the absorbent used is Sofnolime® 8-12 any usage time you have put on the scrubber since it was packed and the time left before the CO<sub>2</sub> absorbent must be disposed.

It is important to remember that using the scrubber beyond the factory tested maximum allowable time per fill of CO<sub>2</sub> absorbent is extremely dangerous and can lead to injury or death.



**WARNING: ONLY USE HOLLIS TESTED AND APPROVED ABSORBANT GRADES AND BRANDS. OTHER ADSORBENTS MAY NOT PERFORM AS EXPECTED OR BE SAFE FOR USE IN THE PRISM 2.**



**WARNING: NEVER EXCEED THE STATED MAXIMUM DURATION OF ABSORBENT. DOING SO WILL EVENTUALLY LEAD TO SERIOUS INJURY OR DEATH.**

## 2: FILL O<sub>2</sub> & DILUENT CYLINDERS, ANALYZE CONTENTS, LABEL CYLINDERS WITH NAME, DATE, AND CONTENTS.

Have the Oxygen cylinder filled with pure, compliant with EN 12021:2014 (in European countries) or E grade USP (in USA) or higher O<sub>2</sub> (See PART 5 Section 1). Fill the diluent cylinder with an appropriate diluting gas for the planned dive(s), also compliant with EN 12021:2014. The Diluent must have a minimum oxygen content of 5% O<sub>2</sub>. Crack the diluent cylinder and sniff the gas. It should have no odor. If it does, suspect contaminants in the fill, have the cylinder inspected by a qualified inspector, then have it re-filled from a new source. Verify the oxygen content of BOTH bottles using a calibrated oxygen analyzer. The oxygen should read 100% and the diluent (if air) 20.9% (see your oxygen analyzers' directions for calibration and environmental variance information).



**WARNING: YOU MUST USE ONLY HOLLIS APPROVED OXYGEN AND DILUENT CYLINDERS AND VALVES WHEN DIVING THE PRISM 2. THESE MUST BE PURCHASED THROUGH YOUR HOLLIS REBRATHER DEALER. FULL SPECIFICATIONS AND PART NUMBERS CAN BE FOUND ON PAGES #31 AND #118.**

O<sub>2</sub> %: Pressure: psi/bar Dil Contents: Pressure: psi/bar MOD: Record Record

Record contents and pressures for both gas supplies and the maximum operating depth (MOD) for the diluent.

$\text{MOD}(\text{fsw}) = 33 \left[ \left( \frac{\text{PO}_2}{\text{fO}_2} \right)^{-1} \right]$
$\text{MOD}(\text{msw}) = 10 \left[ \left( \frac{\text{PO}_2}{\text{fO}_2} \right)^{-1} \right]$



**WARNING: USE GREAT CARE WHEN HANDLING OR OPENING OXYGEN CYLINDERS. OPEN CYLINDERS SLOWLY. NEVER FAST FILL AN OXYGEN CYLINDER AND ALLOW A “HOT” CYLINDER TIME TO COOL TO AMBIENT TEMPERATURES BEFORE USE.**



\*NOTE: You can dive the PRISM 2 using oxygen of less than 100% purity. See the “Cal. PO<sub>2</sub> Function” in the PRISM 2 Displays and Electronics User Manual for instructions to do so.

### 3: INSTALL REGULATORS + HOSES ON H-PLATE

Install the oxygen regulator and hoses on the right side of the H-plate by running all the hoses under the bottom cylinder band strap on the inside of the cylinder bracket with the oxygen 1st stage valve facing outward toward where the cylinder will be installed. Leave the Solenoid feed hose (shortest hose) loose. Then run the other two hoses (HP & LP) under the top cylinder band as well (*Fig. 2.76*). Install the diluent regulator and hoses on the left side (head facing up) by running all the hoses under the bottom and top cylinder band strap on the inside of the cylinder bracket with the oxygen 1st stage valve facing outward (*Fig. 2.77*).

#### **B: Run O<sub>2</sub> solenoid hose between right side head mount flange & H-plate.**

Run the solenoid supply hose in the channel created between the right side head mount flange and the bucket mount. Screw the hose fitting onto the solenoid and hand tighten (*Fig. 2.78*)



Fig. 2.76



Fig. 2.77



Fig. 2.78

## 4: INSTALL BLADDER, YOKE + BACKPLATE ONTO H-PLATE: 4 STEPS

### A: Install carriage bolts onto H-Plate and secure with nylon keepers.

Install both carriage bolts into the square bolt holes in the H-Plate and secure them in place with a nylon bolt keeper. (Fig. 2.79)

### B: Install BCD on H-plate (inflator facing H-plate)

Carefully install the bladder onto the 2 harness mounting bolts of the H-plate, making sure that the inflator mechanism is facing the H-Plate (Fig. 2.80). Take care to not accidentally push the mounting bolts out of the nylon keepers as you run the bolts through the bladder mounting grommets.

The BCD has three mounting grommet positions. Depending on your trim in the water, you may want to raise or lower the BCD position on the H-plate. It is recommended that you begin using the middle position. Then adjust position, if needed, to aid in proper trim as experience is gained on the unit.

You can run all the gas supply hoses and SPGs through the cylinder band slots for a cleaner hose routing (Fig 2.80). You may find it easier pull the hoses through the cylinder band slots if you install the butterfly bolts onto the bolts first. Remove the butterfly bolts after pulling the hoses through.

### C: Install yoke harness - Fastex clips facing bladder

Place the counterlung yoke on top of the bladder with the plastic Fastex clips facing the bladder (Fig. 2.81). Take care to not accidentally push the mounting bolts out of the nylon keepers as you run the bolts through the yoke mounting holes. Like the BCD, the yoke has three mounting grommets. Both your height and girth will dictate which adjustment point you should use.



Fig. 2.79



Fig. 2.80



Fig. 2.81

**D: Install the counterlung side straps to the backplate**

Using bookend screws attach both counterlung side straps to the circular hole above the waist strap on both sides of the waist strap (Fig 2.82).



Fig. 2.82

**E: Install the counterlung pull down straps to the waist strap**

Thread the waist strap webbing on one side through the tri-glide of one of the counterlung pull down straps (Fig. 2.83 & 2.84). Repeat on the other side with the other pull down strap. It will be necessary to make an initial adjustment; so they hold the counterlungs straight down from the shoulder.



Fig. 2.83

**F: Install backplate & harness - Place washers and tighten butterfly nuts**

Place the backplate carefully on the two mounting bolts and secure the assembly in place using the two stainless steel washers and butterfly nuts. Tighten the butterfly nuts by hand.

**6: ATTACH COUNTERLUNGS TO YOKE: 3 STEPS**

**A: Insure inhale counterlung is on right side (bladder & yoke facing up)**

Verify that the inhale counterlung is on the right side by checking that the lung you are installing on the right has the ADV on the front. The exhalation lung will go on the left side and has the OPV on it.



Fig. 2.84

**B: Line up Velcro parts and compress**

Press the Velcro pieces together to assure a firm adhesion of the parts.

**C: Clip Fastex buckles in place**

Attach the plastic Fastex clips of the yoke to the counterlungs making sure they lock into place (Fig. 2.85). Attach the lower large Fastex buckle on the waist belt webbing to the Fastex buckle at the bottom of the counterlung (Fig. 2.86) and the side strap webbing attached to the backplate to the small Fastex clip at the lower side of the counterlung.



Fig. 2.85



Fig. 2.86

## 7: INSTALL COUNTERLUNG BREATHING HOSES TO HEAD: 2 STEPS

### A: Clean/Lubricate O-rings, O-ring Grooves And Mating Surfaces

Remove, clean and prepare the O-ring(s), O-ring groove and mating surface for use, or replace if worn or damaged.

### B: Install hose nuts finger tight. Do not over-tighten.

To properly attach the counterlung hoses to the head, put the hose mount into the head connector (*Fig. 2.87 & 2.88*) and push down until firmly seated against the stainless steel ring on the fitting. Hand-tighten the nut, but do not over-tighten it, as over-tightening will only make removal more difficult. The white nut on the inhalation hose is a reverse thread to insure it is not accidentally attached to the exhalation port. The Inhalation port on the head has a white bar to correspond with the white nut. Gently pull on the hose to insure that the assembly is firmly in place.



Fig. 2.87



Fig. 2.88

## 8: ATTACH GAS SUPPLY HOSES TO DILUENT AND OXYGEN ADDITION VALVES ON COUNTERLUNGS + BCD INFLATOR: 2 STEPS

### A: Attach all 3 QD fittings. Pull on hoses to make sure they are secure

Each counterlung will have one supply hose which needs to be firmly attached to its corresponding gas addition valve. Verify you are attaching the correct supply hose to its valve on the counterlung, then pull up on the locking sleeve, insert the female quick disconnect attachment onto the male nib and release the sleeve. Pull on the hose to verify that the hose is securely connected. Connect one of the diluent hoses to the BCD inflator.

## 9: ASSEMBLE DSV AND HOSES, CHECK AND INSTALL: 6 STEPS

In steps 3 & 4 of the pre-assembly checks you verified the operation of the three main sub-assemblies that make up the DSV assembly. Now you will put together the assembly, check its operation and install the assembly on the counterlungs.

### A: Open/close, purge, mouthpiece

Open and close the DSV shut down lever to make sure it is not binding or was damaged during transit. With the DSV in the closed position, blow into the closed mouthpiece to make sure the water purge hole is not obstructed.

### B: Inspect mushroom valves

Look at the top of the DSV. The arrow denotes the gas flow direction (*Fig. 2.89*) and points at the exhalation mushroom valve (*Fig. 2.90*). Make sure the mushroom valve is intact and in good condition and the seat is firmly seated in the DSV assembly.

### C: Install hoses onto DSV

#### DSV:

Take the inhalation hose (mushroom valve installed in the counterweight side of the hose on DSV hose) (*Fig. 2.91*) and thread the nickel-plated brass counterweight onto the inhalation side of the DSV body (the flow direction arrow on the DSV points away from the inhalation side). Hand tighten only.

Take the exhalation hose and thread the nickel-plated brass counterweight onto the DSV exhalation side. Hand tighten only.

### D: Perform a mushroom valve sealing test (“stereo check”)

To test that the assembly will flow gas in one direction only and the valves are sealing properly, open the DSV and place the mouthpiece in your mouth. To check the inhalation mushroom valve, seal the exhale hose elbow on your right cheek and put the inhale hose elbow by your left ear and blow gently into the DSV. You should not be able to exhale, or hear any air escaping from the inhale side. To check the exhale mushroom valve, reverse the elbows (left on cheek, right at ear) and attempt to inhale from the DSV. If either mushroom valve fails to seal, disassemble the DSV assembly, clean or replace the failing mushroom valves and retest.



Fig. 2.89



Fig. 2.90



Fig. 2.91



## E: Install DSV onto counterlungs paying attention to flow direction arrow

Take the inhalation side elbow and insert it into the counterlung at approximately an outward facing 45° angle (away from the unit's center) (Fig. 2.92). Both elbows are keyed (Fig. 2.93) so the DSV assembly cannot be accidentally reversed. If they are accidentally reversed and screwed down, they will not lock in place and you will be able to spin them even when they are fully secured. Screw the inhalation hose onto the inhalation counterlung (left) and tighten it down. Do the same with the exhalation hose elbow, installing it on the exhalation (right) counterlung. With the DSV mouthpiece pointing upwards, turn it approximately 45° towards the rebreather (Fig. 2.94). This should be a good starting point for the mouthpiece angle, but the angle should be set for the diver's preference. You can continue to rotate the mouthpiece angle to find out what works best for you.



Fig. 2.92



Fig. 2.93



Fig. 2.94

**WARNING: WHEN MOUNTING AND ADJUSTING THE DSV ON THE HOSES, BE VERY CAREFUL NOT TO ADJUST THE ANGLE OF THE MOUTHPIECE BY TWISTING ONE OF THE HOSES AS THIS COULD CAUSE THE HOSES TO KINK DURING DIVING. A KINKED HOSE WILL INCREASE THE WORK OF BREATHING AND AS A RESULT POSSIBLY CAUSE THE DIVER TO RETAIN AN UNHEALTHY LEVEL OF CO<sub>2</sub>, WHICH OVER TIME COULD LEAD TO UNCONSCIOUSNESS AND POSSIBLY DROWNING.**



## F: Install HUD (Heads Up Display) holder. Fix / attach cable to breathing hose

**NOTE:** If there is any doubt about hose twisting, unscrew the counterweight from the DSV. Watch how the hose comes to rest against the counterlung. Lift the hose up to its diving position. (You can look at the hose clamp to visually mark where the top of the hose should be.) Re-install the DSV



The HUD is held on to either the right or left DSV counterweight by a plastic c-clamp (Fig. 2.95). The c-clamp is designed to come off from the counterweighted nut fairly easily in the event of an impact or entanglement. This design protects the wiring from damage.

How the wiring is run is user choice, but take caution not to run the wiring in such a way as to make it an entanglement hazard. The HUD wiring from the head can route down the inside of the breathing hoses.



Fig. 2.95

## 4: INSTALL BLADDER, YOKE + BACKPLATE ONTO H-PLATE: 4 STEPS

### A: Install carriage bolts onto H-Plate and secure with nylon keepers.

Install both carriage bolts into the square bolt holes in the H-Plate and secure them in place with a nylon bolt keeper. (Fig. 2.96)

### B: Install BCD on H-plate (inflator facing H-plate)

Carefully install the bladder onto the 2 harness mounting bolts of the H-plate, making sure that the inflator mechanism is facing the H-Plate (Fig. 2.97). Take care to not accidentally push the mounting bolts out of the nylon keepers as you run the bolts through the bladder mounting grommets.

The BCD has three mounting grommet positions. Depending on your trim in the water, you may want to raise or lower the BCD position on the H-plate. It is recommended that you begin using the middle position. Then adjust position, if needed, to aid in proper trim as experience is gained on the unit.

You can run all the gas supply hoses (except solenoid supply hose) and SPGs through the cylinder band slots for a cleaner hose routing (Fig 2.97). You may find it easier pull the hoses through the cylinder band slots if you install the butterfly bolts onto the bolts first. Remove the butterfly bolts after pulling the hoses through.

### C: Install Back-Mounted Counterlung - T-Pieces facing bladder

Place the Back Mounted counterlung on top of the bladder with the T-Pieces facing the bladder (Fig. 2.98). Take care to not accidentally push the mounting bolts out of the nylon keepers as you run the bolts through the yoke mounting holes. Like the BCD, the yoke has three mounting grommets. Both your height and girth will dictate which adjustment point you should use.

### F: Install backplate & harness - Place washers and tighten butterfly nuts

Place the backplate carefully on the two mounting bolts and secure the assembly in place using the two stainless steel washers and butterfly nuts. Tighten the butterfly nuts by hand (Fig. 2.99).



Fig. 2.96



Fig. 2.97



Fig. 2.98



Fig. 2.99

## 5: ATTACH COUNTERLUNGS TO HARNESS

Undo the 3 piece Velcro strap and place the harness shoulder strap on top of the counterlung. Place the single Velcro piece (Loop side) between the double Velcro straps (Hook sides) and squeeze to lock the loop & hook together. Repeat for the other side.



Fig. 2.100

## 8: ATTACH GAS SUPPLY HOSES TO DILUENT AND OXYGEN MANUAL ADDITION BLOCKS, ADV SWIVEL + BCD INFLATOR: 3 STEPS

**A: Attach all 3 QD fittings. Pull on hoses to make sure they are secure.**

### 1: Manual Addition Blocks:

Each Manual addition block will have one supply hose which needs to be firmly attached to its corresponding gas addition valve. Verify you are attaching the correct supply hose to its valve on the Manual Addition Blocks (Green coded hose to O<sub>2</sub> Block, Black hose to Diluent Block) (Fig. 2.101) then pull up on the locking sleeve, insert the female quick disconnect attachment onto the male nib and release the sleeve. Pull on the hose to verify that the hose is securely connected.



Fig. 2.101

### 2: BCD Inflation Hose:

Slide the BCD supply hose through the loop holding the BCD dump valve hose and pull down towards to the Inflator/Deflater. There is a silicone loop on the dump valve hose which you can slide the supply hose through then connect the QD fitting onto the Male QD fitting on the Inflator/Deflater. Pull on the supply hose to make sure the QD connector is firmly connected (Fig. 2.102).



Fig. 2.102

### 3: ADV Supply Hose:

The ADV swivel has a male threaded connector inlet. Thread the ADV supply hose onto the fitting by hand. Do not use tools as excess force can damage the T-Piece (Fig. 2.103)



Fig. 2.103



**WARNING: THERE IS A SIGNIFICANT RISK OF EXCESSIVE GAS LOSS FROM THE BMCL OVER PRESSURE VALVE (OPV) IN A VERTICAL HEADS DOWN POSITION (-45 AND -90 DEGREE POSITIONS) DURING THE DIVE. EXTRA MONITORING OF ONBOARD BREATHING GAS AND CYLINDER CONTENTS SHOULD TAKE PLACE IF YOU ARE FORCED INTO THIS POSITION, HOWEVER IT IS NOT RECOMMENDED TO DIVE IN A VERTICAL POSITION AT ANY TIME.**

## 7: INSTALL COUNTERLUNG BREATHING HOSES TO HEAD: 2 STEPS

### A: Clean/Lubricate O-rings, O-ring Grooves And Mating Surfaces

Remove, clean and prepare the O-ring(s), O-ring groove and mating surface for use, or replace if worn or damaged.

### B: Install hose nuts finger tight. Do not over-tighten.

To properly attach the counterlung hoses to the head, put the hose mount into the head connector (*Fig. 2.104 & 1.105*) and push down until firmly seated against the stainless steel ring on the fitting. Hand-tighten the nut, but do not over-tighten it, as over-tightening will only make removal more difficult. The white nut on the inhalation hose is a reverse thread to insure it is not accidentally attached to the exhalation port. The Inhalation port on the head has a white bar to correspond with the white nut. Gently pull on the hose to insure that the assembly is firmly in place.



Fig. 2.104



Fig. 2.105

## 8: ATTACH GAS SUPPLY HOSES TO DILUENT AND OXYGEN ADDITION VALVES ON COUNTERLUNGS + BCD INFLATOR: 2 STEPS

### A: Attach all 3 QD fittings. Pull on hoses to make sure they are secure

Each counterlung will have one supply hose which needs to be firmly attached to its corresponding gas addition valve. Verify you are attaching the correct supply hose to its valve on the counterlung, then pull up on the locking sleeve, insert the female quick disconnect attachment onto the male nib and release the sleeve. Pull on the hose to verify that the hose is securely connected. Connect one of the diluent hoses to the BCD inflator.

## 9: ASSEMBLE DSV AND HOSES, CHECK AND INSTALL: 6 STEPS

In steps 3 & 4 of the pre-assembly checks you verified the operation of the three main sub-assemblies that make up the DSV assembly. Now you will put together the assembly, check its operation and install the assembly on the counterlungs.

### A: Open/close, purge, mouthpiece

Open and close the DSV shut down lever to make sure it is not binding or was damaged during transit. With the DSV in the closed position, blow into the closed mouthpiece to make sure the water purge hole is not obstructed.

### B: Inspect mushroom valves

Look at the top of the DSV. The arrow denotes the gas flow direction (*Fig. 2.106*) and points at the exhalation mushroom valve (*Fig. 2.107*). Make sure the mushroom valve is intact and in good condition and the seat is firmly seated in the DSV assembly.

### C: Install hoses onto DSV

#### DSV:

Take the inhalation hose (mushroom valve installed in the counterweight side of the hose on DSV hose) (*Fig. 2.108*) and thread the nickel-plated brass counterweight onto the inhalation side of the DSV body (the flow direction arrow on the DSV points away from the inhalation side). Hand tighten only.

Take the exhalation hose and thread the nickel-plated brass counterweight onto the DSV exhalation side. Hand tighten only.



Fig. 2.106



Fig. 2.107



Fig. 2.108

## **D: Perform a mushroom valve sealing test (“stereo check”)**

Because the BMCL system is different from the FMCLs insofar as you cannot disconnect the breathing hoses to do a stereo check, you will have to fold over the hose to restrict airflow to test that the assembly will flow gas in one direction only and the valves are sealing properly. Open the DSV and place the mouthpiece in your mouth. To check the inhalation mushroom valve, seal the exhale hose by doubling it over about half way down the hose to cut-off any air flow, and blow gently into the DSV. You should not be able to exhale, or hear any air escaping from the inhale side. To check the exhale mushroom valve, double over the Inhalation hose and attempt to inhale from the DSV. If either mushroom valve fails to seal, disassemble the DSV assembly, clean or replace the failing mushroom valves and retest.

## **F: Install HUD (Heads Up Display) holder. Fix / attach cable to breathing hose**

The HUD is held on to either the right or left DSV counterweight by a plastic c-clamp (*Fig. 2.109*). The c-clamp is designed to come off from the counterweighted nut fairly easily in the event of an impact or entanglement. This design protects the wiring from damage.

How the wiring is run is user choice, but take caution not to run the wiring in such a way as to make it an entanglement hazard. The HUD wiring from the head can route down the inside of the breathing hoses.



Fig. 2.109

## 10: CLEAN HEAD TO BUCKET SEALING O-RINGS, O-RING GROOVES AND LUBRICATE O-RINGS

In the Component Inspection you checked and if needed, cleaned the bucket sealing O-rings. If you are assembling the PRISM 2 right after your inspection, you do not need to re-clean the O-rings. You can simply use this step to verify that nothing had fallen onto the O-rings that could cause a leak during dive operations.

If the PRISM 2 has been transported or disassembled in such a way that debris could have gotten on the O-rings, we recommend repeating this step. We have duplicated these steps here, instead of making you go back in the manual. (If you don't need to clean the O-rings, skip ahead to Step 11):

The head to bucket sealing flange incorporates two bucket sealing O-rings. It is important that you clean and check both O-rings and their seating surfaces whenever the bucket has been removed from the seating flange.

To begin the cleaning process, using an O-ring removal tool, remove the two O-rings from their grooves (*Fig. 2.100*) starting with the O-ring closest to the head (#1) (*Fig. 2.111*) and lay it on a clean towel. Next, remove the O-ring closest to the edge of the bucket flange (#2) (*Fig. 2.112*). Never use any sharp or metal objects to remove the O-rings, as that would damage the O-ring and/or the seating surface. Never over-stretch the O-rings while removing them.

Clean any debris (usually small particles of soda lime) and lubricant on the O-rings with a lint-free towel. Once clean, run the O-rings through your fingers feeling for any nicks or left over debris while visually inspecting them at the same time. There must be no lint, hair, or particles of any kind on the cleaned O-ring, since debris on the O-ring would cause a seal failure. If you find any damage to the O-ring, it must be replaced with a new O-ring from your spares kit.

Lay the 2 cleaned (but not yet lubricated) O-rings aside on a clean surface. Clean the seating surface on the head flange, making sure to remove any debris that may have collected in the O-ring grooves.

Put a small dab of lubricant on your forefinger and lightly coat each O-ring with a sheen of lubricant by running the O-ring between your forefinger and thumb. While you are doing this, feel for any leftover debris and if found, re-clean the O-ring and reapply fresh lubricant. Immediately replace all cleaned and lubricant-treated O-ring back on the head after you lube them, in the opposite order in which you took them off.



Fig. 2.110



Fig. 2.111



Fig. 2.112



## 11: CLEAN RED CO<sub>2</sub> SEAL AND SECURE IN PLACE: 2 STEPS

The Red CO<sub>2</sub> Seal is a large soft red silicone gasket that resides on the underside of the head in a channel on the face of the head plate, next to the three O<sub>2</sub> sensors (Fig. 2.113).

### A: Make sure there is no debris, dust or lubricant

Check the face of the red CO<sub>2</sub> seal to insure there is no old absorbent or other debris that could compromise a proper seal of the basket. Remove the seal and check that there is no lubricant in the seal channel that could cause the seal to come loose during assembly. Do not lubricate the red CO<sub>2</sub> seal. Clean the seal channel of any debris or lubricant.



Fig. 2.113



**WARNING: THE RED CO<sub>2</sub> SEAL IS A CRITICAL COMPONENT OF A PROPERLY FUNCTIONING BREATHING LOOP. IF THE GASKET IS LEFT OUT DURING OPERATION, THE UNIT WILL NOT SCRUB ANY CO<sub>2</sub>. RESULTING IN 100% BREAKTHROUGH. FOR THIS REASON, YOU MUST VERIFY THAT THE GASKET IS IN PLACE, SEATED PROPERLY IN ITS GROOVE, CLEAN AND UNDAMAGED. FAILURE TO CHECK THE RED CO<sub>2</sub> SEAL WILL LEAD TO SERIOUS INJURY OR DEATH.**

### B: Make sure the Red CO<sub>2</sub> Seal is firmly seated in its groove (triple check)

Check that the gasket is in place and securely seated in its channel in the head plate by pushing down on it all the way around the gasket. Recheck that the gasket is properly seated just before you install the scrubber basket and bucket assembly on the head.

## 12: CHECK FILLED CO<sub>2</sub> SCRUBBER BASKET: 2 STEPS

Regardless of whether you packed your scrubber basket ten minutes ago or yesterday, you must recheck the basket one final time before loading it into the rebreather. This is especially true if the absorbent might have had an opportunity to settle during transportation, or if the basket top came loose in handling. Remember, a properly packed absorbent basket is essential for a safe dive.

### A: Basket top secure

Make sure the basket top is tight and fully seated on the basket. The bottom of the basket top should line up with the bottom of the threaded section of the basket cage. (Fig. 2.114)



Fig. 2.114

### **B: Check for settling and firmness of absorbent bed**

Just as you do when packing the basket, feel the absorbent from bottom to top. It should feel evenly dense throughout. Put slight pressure on the mesh by squeezing it. The applied pressure should not displace grains of absorbent. If the absorbent is not tight and even throughout, you must re-pack the scrubber.

## **13: CHECK SCRUBBER BUCKET: 4 STEPS**

### **A: Clean bucket sealing surface**

Before mounting the bucket to the head, give the bucket flange O-rings one last look for hair, lint, dirt or anything that might have fallen onto the lubricant. Clean the sealing surface of the bucket with a clean, lint-free cloth. Check that there is no debris or hairs left on the sealing surface that could cause a slow leak into the bucket.

### **B: Basket compression spring installed and functional**

Press down on the basket compression spring, making sure that the spring is functioning correctly and is firmly held in place by the retaining nut.

### **C: Install bucket moisture pads**

Place the supplied moisture pad at the bottom of the bucket

### **D: Make sure the pad is not resting on or interfering with the basket compression spring**

Make sure the absorbing pad is laying flat and it is not hung up on the spring or spring pad. (Fig. 2.115)

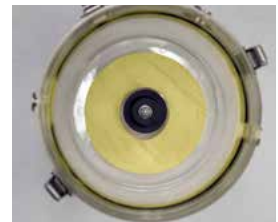

Fig. 2.115

#### 14: PLACE CO<sub>2</sub> BASKET IN BUCKET, CONFIRM CENTER TUBE OPENING UP, MOUNT AND SEAL BUCKET TO HEAD

Gently place the basket in the bucket making sure the center breathing tube is facing up. (Fig. 2.116)

Push down on the basket top and make sure it springs back. If it does not move, you have either placed the basket in the bucket up side down, or the spring assembly is not working correctly. Open up the nylon bucket strap and slide the bucket underneath making sure the top bucket latch is centered and facing away from the backplate. Open all 3 bucket latches and fold back the hooks, so they do not get caught between the bucket and head.



Fig. 2.116



**WARNING: IF, WHEN YOU INHALE FROM THE LOOP YOU SEAL THE BUCKET ON THE HEAD AND IT CAUSES THE EXHALLATION LUNG TO COLLAPSE COMPLETELY, THIS IS AN INDICATOR THAT YOU INSTALLED THE SCRUBBER BASKET UPSIDE DOWN IN THE BUCKET. THE BUCKET SPRING FORCES THE FLAT BASKET TOP ONTO THE RED CO<sub>2</sub> SEAL AS A SAFETY PRECAUTION, STOPPING GAS FLOW AROUND THE LOOP.**

Put your hand at the bottom of the bucket and push it up toward the head, making sure not to twist or push at an angle.

When the bucket is close enough to the head that the latches can catch onto the Latch Keeper, flip the two side latches onto the keeper and lock them in place. Verify that the latches are locked by attempting to pull up on them. Then flip the middle latch into place and lock it down. Then verify it is locked too. Look at the two O-rings through the clear bucket to verify that they are in their grooves and are not twisted or pinched.

Intra -Dive: No  Yes

Scrubber: New  Used

Total Time Used On Scrubber:

## OPERATIONAL CHECKLIST LEVEL 1

Name: Date: / / \_

- 1. Assembly Checklist Completed
- 2. Install Analyzed + Labeled Gas Cylinders
- 3. Turn On Wrist Display
- 4. Turn On HUD - Check Battery Status
- 5. Oxygen System Leak Test  
(hold for 30 seconds minimum)
- 6. Negative Pressure Test  
(hold for 1 minute minimum)
- 7. Positive Pressure Test  
(hold for 1 minute minimum)
- 8. Flush Loop (2 times)
- 9. Calibrate Wrist & HUD  
(hold for 30 seconds minimum)
- 10. Check Solenoid & Wrist Display Battery
- 11. Install Cover
- 12. Diluent System Leak Test
- 13. Check ADV if equipped, and BCD
- 14. Pre-Breathe (5 minutes)

### If Diving Immediately:

Continue with "Pre-Dive Checks".

### If NOT Diving Immediately:

Close O<sub>2</sub> + diluent cylinder valves, drain hoses, turn off electronics and secure unit.

## Pre-Dive Checks:

- 15. Weights
- 16. HUD And Wrist Displays On
- 17. Cylinder Valves Open
- 18. Verify Setpoint And Loop Contents
- 19. Don The Prism 2
- 20. Pre-Jump  
(See hang tag on rebreather.)

Name: Date: / / \_

Intra -Dive: No  Yes   
 Scrubber: New  Used   
 Total Time Used On Scrubber:

- 1. Assembly Checklist Completed
- 2. Install Analyzed + Labeled Gas Cylinders
- 3. Turn On Wrist Display.
  - A. Check O<sub>2</sub> cell mV readings in air - 3 presses right button (acceptable: 8.5 mV to 14 mV - replace if needed)
  - B. Change to Setpoint .19
- 4. Turn On HUD - Check Battery Status
- 5. Oxygen System Leak Test
  - (hold for 30 seconds minimum)
  - A. Slowly open oxygen valve, pressurize hoses, close valve
  - B. Watch oxygen pressure gauge for pressure loss
  - C. Slowly open oxygen valve
- 6. Negative Pressure Test
  - (hold for 1 minute minimum)
  - A. Open DSV
  - B. Inhale from DSV in CC mode, exhaling through nose until counterlungs are fully collapsed
  - C. Close DSV
  - D. Allow to sit for one minute; watch for signs of leaks.
- 7. Positive Pressure Test
  - (hold for 1 minute minimum)
  - A. Close OPV
  - B. Fill loop fully with oxygen using manual oxygen addition valve until OPV vents
  - C. Allow to sit for one minute, watch for signs of leaks
  - D. Open DSV evacuate loop contents
- 8. Flush Loop (2 times)
  - A. Close DSV
  - B. Fill loop with oxygen until OPV vents
  - C. Evacuate loop fully
  - D. Repeat steps A. & B.
  - E. Open DSV to equalize pressure to ambient pressure. Close DSV.
- 9. Calibrate Wrist Display & HUD:
  - Wrist Display:
    - A. Menu to calibrate (2 X MENU - left button)
    - B. Press Select (right button) twice to calibrate
    - C. Check mV readings in O<sub>2</sub> (acceptable: 40.6 mV - 66.9 mV)
  - HUD:
    - D. 2 presses on HUD switch - press & hold to confirm

- 10. Check Solenoid & Wrist Display Battery
  - A. Setpoint to high (>1.1)
  - B. Solenoid fires, O<sub>2</sub> injection verified
  - C. Change setpoint to .19
  - D. Solenoid and wrist display battery check [acceptable: Ext V ≥ 7 / Int V ≥ 3.18] (8 X SELECT - Right button)
- 11. Install Cover
- 12. Diluent System Leak Test
  - (hold for 30 seconds minimum)
  - A. Open diluent valve - pressurize- close valve
  - B. Watch diluent pressure gauge for pressure loss
  - C. Open diluent cylinder
- 13. Check ADV and BCD
  - A. Open DSV, inhale from loop until ADV engages, dropping loop PO<sub>2</sub>
  - B. BCD Inflation + deflation mechanisms / air holding
- 14. Pre-Breathe
  - A. Change wrist display to low setpoint
  - B. Block nose and begin breathing from the PRISM 2 while seated in a safe location)
  - C. Observe setpoint maintenance

**If Diving Immediately:  
Continue with “Pre-Dive Checks”.**

**If NOT Diving Immediately:  
Close O<sub>2</sub> + diluent cylinder valves, drain hoses, turn off electronics, and secure unit.**

- Pre-Dive Checks:**
- 15. Weights
  - 16. HUD And Wrist Displays On
  - 17. Cylinder valves open
  - 18. Verify Setpoint And Loop Contents
  - 19. Don The Prism 2
  - 20. Pre-Jump (See hang tag on rebreather)
    - A. Begin Breathing Unit
    - B. Check: ADV, O<sub>2</sub> Add, Dil Add; BCD
    - C. Check SPG: O<sub>2</sub>, Dil; OC
    - D. Observe Setpoint Maintained
    - E. Always Know PPO<sub>2</sub> & Have Fun

# OPERATIONAL CHECKLIST LEVEL 3 W/INSTRUCTIONS



**WARNING: ATTEMPTING TO DIVE A PRISM 2 THAT YOU HAVE NOT RUN THROUGH COMPLETE OPERATIONAL AND PRE-DIVE CHECKS IS A SURE WAY TO KILL YOURSELF! NEVER DIVE A REBREATHER THAT YOU HAVE PERSONALLY VERIFIED HAS PASSED ALL OPERATIONAL AND PRE-DIVE CHECKS.**

## 1: ASSEMBLY CHECKLIST COMPLETED



**NOTE:** Get in the habit of checking off each item on the checklist as you go and DO NOT skip around on the list. Good checklist habits are the best way to insure that you have assembled your PRISM 2 correctly, and insure you have not left out a critical step.

## 2: INSTALL ANALYZED + LABELED GAS CYLINDERS

Place the diluent cylinder under the two cylinder straps on the divers left. Place the O<sub>2</sub> cylinder on the divers right. It is very important that you put the correct cylinder in the appropriate position. Screw the oxygen first stage into the valve and then do the same with the diluent side of the system. Tighten the cylinder bands.



### **NOTE: EUROPEAN OXYGEN REGULATOR**

European models of the PRISM 2 Oxygen Regulator utilize a M26 fitting for attachment. The threads are different than standard ISO 12209 fittings to avoid confusion. Though Installation is the same.

## 3: TURN ON WRIST DISPLAY.

**A: Check O<sub>2</sub> Cell mV Readings In Air, Replace If Out Of Range  
(acceptable: 8.5 mV to 14 mV)**

**Record O<sub>2</sub> Cell mV readings in air:** #1 \_\_\_\_ #2 \_\_\_\_ #3 \_\_\_\_ Turn on the Wrist Display. Press the select (right) button three times to view the millivolt screen. Record the mV outputs for each cell. You will use these readings to check linearity. Do so by multiplying these readings by 4.75 (4.76 if O<sub>2</sub> content set to 100%) and comparing them to the readings after flushing the loop with pure O<sub>2</sub>.

### **B. Setpoint to 0.19 (9X menu - left button)**

If not already set, you will need to set the active setpoint to 0.19 so the computer is not automatically injecting O<sub>2</sub> into the loop. Depress the menu button 9 times until you see the “Setpoint .19” menu item, then press the select button once to select it. This will, in effect, shut off the solenoid while the O<sub>2</sub> sensors are exposed to air.



**NOTE:** Setting .19 as your setpoint may NOT shut off the solenoid is you are above 3000ft / 914m altitude.

#### 4. TURN ON HUD - BATTERY CHECK

- OK**       **Replaced & OK**

Turn the HUD power on with a single press of the switch on the side of the HUD and verify that the HUD runs through its start-up sequence (all LEDs illuminate, indicate up position then switch to O<sub>2</sub> status or fault). If all lights continuously glow for 30 seconds upon start-up, the Heads Up Display battery is low and must be changed, before diving.



**WARNING: THE HEADS UP DISPLAY WILL ONLY GIVE A BATTERY WARNING ON START-UP AND WILL NOT ALERT THE USER TO A CRITICALLY LOW BATTERY WHILE DIVING. THEREFORE, YOU MUST CHANGE THE HEADS UP DISPLAY BATTERY WHENEVER THE ELECTRONICS ILLUMINATE THE LED'S FOR 30 SECONDS UPON START-UP.**

#### 5: OXYGEN SYSTEM LEAK TEST (HOLD FOR 30 SECONDS MIN.)

You will check to make sure there are no small leaks in the oxygen delivery system (1st stages, hoses QD fittings, valves).

##### **A: Slowly open oxygen valve, pressurize hoses, close valve**

Slowly open the oxygen cylinder valve. Allow the hoses to fully stretch and pressurize. With new hoses, allow them to stretch for a minute or two while the cylinder is on. Shut off the oxygen cylinder valve.

##### **B: Watch oxygen pressure gauge for pressure drop**

Listen for leaks and check that the pressure on the gauge has not dropped after a minute or two.

##### **C: Slowly open oxygen valve**

Slowly open the oxygen valve.



**NOTE:** At any time, but especially for extended range diving, it is advisable to allow the loop to sit for at least 5 minutes before checking to see if vacuum or pressure is being lost. Small leaks may not allow enough pressure or vacuum to escape in the first minute or two of the tests to be noticeable by palpation of the counterlungs, but may allow enough water into the loop during diving to become problematic. Small leaks will also usually show up in the bubble check but it is usually less time-consuming to identify and correct leaks at this stage of set-up.



## 6: NEGATIVE PRESSURE TEST (HOLD FOR 1 MINUTE MINIMUM)

The negative pressure test will check for the types of leaks that may not show during a positive pressure test. These types of leaks are fairly rare but are just as potentially dangerous, so it is extremely important to perform the test. Make a mental note of either the mV readings or the PO<sub>2</sub> readings on the Wrist Display prior to starting the test. If the negative pressure in the loop during this test is strong enough, you will notice that the mV or PO<sub>2</sub> readings drop 1 or 2 10ths and will remain at those values as long as there are no leaks in the loop. If the readings do not drop at all, it is possible that you cannot create enough of a vacuum to drop the values, or you have a leak in the system that will not allow a vacuum to form at all.

We do the negative pressure test at this stage of the checklist because we are also preparing the loop for an oxygen flush, which we will begin doing during the positive pressure test. Performing the negative pressure test now removes as much air from the loop as possible.

### A: Open DSV

Open the DSV and remove as much air as possible from the counterlungs (*Fig. 2.117*).

### B: Inhale from DSV in CC mode, exhaling through nose until counterlungs are fully collapsed

Now place the open DSV in your mouth, and while inhaling from your mouth and exhaling through your nose, get as much air as possible out of the loop. Continue until the counterlungs have fully collapsed and you cannot pull any more air out of the loop, leaving a slight vacuum, “negative pressure”, in the loop.

### C: Close DSV, evacuate loop contents

With the loop drained of as much gas as possible and the DSV still in your mouth, shut down the DSV. Do not allow air back into the loop while shutting down the DSV



Fig. 2.117

**D: Allow to sit for one minute, watch for signs of leaks on Wrist  
Display PO<sub>2</sub> /mV readings**

After you pull a vacuum on the loop, the counterlungs will be fully collapsed and hard to the touch. Allow the loop to sit for at least one minute while you watch the Wrist Display mV or PO<sub>2</sub> readings for a change and/or watch the counterlungs and loop hoses to see if the material appears to relax, even slightly. If the loop does appear to be losing vacuum, you must track down and fix the leak, or leaks, prior to diving.

Leaks that only show up in negative pressure tests but not positive pressure tests are rare. However, they are the hardest to find because you cannot do a simple bubble check to find them. Usually they are the result of a FMCL drain locking collar not being tightened which could cause the negative pressure in the loop to open the valve and allow air in, or debris in the BMCL drain. Another possibility is debris in the FMCL OPV mushroom valve or seat. A flush with fresh water might remove the material creating the leak. Worn O-rings in the DSV may also show up in the negative leak test.



**NEVER DIVE A PRISM 2 WHICH CANNOT PASS A POSITIVE OR NEGATIVE PRESSURE TEST AS IT INDICATES A COMPROMISED (NOT WATER TIGHT) LOOP. LEAKS NEVER GET BETTER UNDERWATER! DIVING WITH A LEAKING LOOP CAN LEAD TO INJURY OR DEATH.**

**7. POSITIVE PRESSURE TEST (HOLD FOR 1 MINUTE MINIMUM)**

The positive pressure test will identify most leaks in the breathing loop. It also begins the process of flushing the loop with oxygen in preparation for calibration of the O<sub>2</sub> sensors.

**A: Close OPV**

Make sure the DSV is closed and turn the OPV (over-pressure valve) fully counter-clockwise to restrict its flow.

**B: Fill loop fully with oxygen using manual oxygen addition valve until OPV vents.**

Depress the manual oxygen addition valve to add oxygen. Continue adding oxygen into the loop until the overpressure valve on the exhalation counterlung begins to release pressure. The counterlungs should feel firm to the touch and remain that way. If the counterlungs lose pressure, you must track down and fix the leak or leaks prior to diving. If the leak is small such that you can not hear gas escaping while the loop is under pressure, you can submerge the rebreather in water and look for a trail of bubbles. (Tanks must be mounted on the first stages prior to submerging the unit to avoid flooding the first stages.) Do not submerge a fully built and absorbent packed unit that rapidly loses air because you could fully flood the unit, ruin your absorbent and destroy the O<sub>2</sub> sensors.



**NEVER DIVE A PRISM 2 WHICH CANNOT PASS A POSITIVE OR NEGATIVE PRESSURE TEST AS IT INDICATES A COMPROMISED (NOT WATER TIGHT) LOOP. LEAKS NEVER GET BETTER UNDERWATER! DIVING WITH A LEAKING LOOP CAN LEAD TO INJURY OR DEATH.**

**C: Allow to sit for one minute, watch for signs of leaks**

Fully fill the loop with oxygen, with the OPV closed, until it vents gas. Allow the loop to sit for at least a minute. Be careful not to jostle the counterlungs as any added external pressure could cause the OPV to activate, releasing internal pressure. You should gently palpate (feel) the counterlungs after filling them and after a few minutes see if they feel the same as they did when you first filled the loop.

**D: Open DSV, evacuate loop contents**

Open the DSV in CC mode and push on the counterlungs to remove as much gas as possible from the loop.

## **8. FLUSH LOOP (2 TIMES)**

Since the DSV is open at this stage, pull another negative.

**A: Close DSV**

Once you have pulled the negative, close the DSV

**B: Fill loop with oxygen until OPV vents**

Press the Manual Oxygen Addition valve as you did during the Positive Pressure Test, and fill the loop until the OPV vents.

**C: Evacuate loop fully**

Pull another negative.

**D: Repeat steps A & B.****E: Open DSV to equalize pressure to ambient pressure. Close DSV**

After the two oxygen flushes, crack open the DSV momentarily to let any positive pressure escape from the loop, returning the loop to ambient pressure.

**9. CALIBRATE WRIST & HUD (HEADS UP DISPLAY)**

*Wrist Display: This step will calibrate the Wrist Display.*



**NOTE:** If the wrist unit electronics do not have a valid O<sub>2</sub> calibration stored in memory, the solenoid will not fire when the system is turned on. If the Wrist Display reads “FAIL” on the O<sub>2</sub> sensor readouts, you will need to watch the mV readings as you add O<sub>2</sub> until they stabilize to verify a proper loop flush.

**A: Menu to calibrate (2X menu - left button) (Fig. 2.118)**

Depress the menu button (left) twice to get to the calibrate screen.

**B: Press select button twice to calibrate**

Depress the “select” button twice to calibrate. Once the Wrist Display accepts calibration, all 3 PO<sub>2</sub> display values will match with the “Cal. PPO<sub>2</sub>” value programmed into the computer during system setup (see “Cal PPO<sub>2</sub>” programming in the PRISM 2 Displays and Electronics User Manual). The system default is 0.98 PO<sub>2</sub>.

**C: Check mV readings in O<sub>2</sub>:**

#1 \_\_\_\_\_ #2 \_\_\_\_\_ #3 \_\_\_\_\_ (acceptable range 40.6 mV to 66.9 mV)

You want to record the millivolt readings so you can monitor the health of the O<sub>2</sub> sensors over time. As the cells age, the current output in both air and pure O<sub>2</sub> will decrease to a point where they can become unstable and unpredictable (Non-linear).

Usually, the cells will exceed their “Use by” date and need to be retired before they become a problem, but occasionally you may get a cell which “goes bad” during its service life (which is printed right on the cells’ label for your safety). Recording these mV readings will allow you to better track cell behavior and aging.



**NOTE:** The electronics might catch an inadequate oxygen flush, as the Millivolt readings from the O<sub>2</sub> sensors in a loop which has not been fully flushed might be too low and the software would reject calibration. Recording the pre - and - post O<sub>2</sub> pressures is one tool in your kit of diagnostic clues when your electronics are rejecting calibration.



Fig. 2.118

Also, recording the mV values in oxygen and comparing those values with previous values can give us a good indicator if we have done a thorough flush of the loop. For instance, if the last time you calibrated the system, the mV values were 55, but a week later they are outputting 45 mV post-flush, you may want to consider flushing more oxygen through the loop to see if those mV values increase as you add more O<sub>2</sub>, which would indicate an incomplete loop flush.

Finally, after you have satisfied yourself that your loop is thoroughly flushed with oxygen, you can do a 2 point field linearity check by multiplying the readings in air (from Step 3) by 4.76. You should get a number that is within a few percentage points of the mV readings recorded here in pure O<sub>2</sub>. While this field test is not a true linearity test as it only compares 2 points, both of which are at ambient pressure and cannot take the place of a true full range (ambient + hyperbaric) linearity test, it is easy to do and doesn't hurt the cell, so why not do the math. (Poor loop flushes or O<sub>2</sub> less than 100% purity will affect these comparisons adversely). Cells which are not linear or are current limited must not be dived.

*HUD:*

**A: 2 presses on HUD power switch**

Press the HUD power switch twice until the indicator is in the middle LED column. PRESS and HOLD the button until all lights in the second column light and then blink. Calibration has now been accepted.

## **10. CHECK SOLENOID & WRIST DISPLAY BATTERIES**

**A: Setpoint to high (>1.1)**

The active setpoint is presently .19 which was set in step 3. Depress the menu button 3 times until "Switch .19 > xx" is displayed on the screen. Depress the select button once to select the programmed low setpoint. Repeat to choose the programmed high setpoint.

It may be necessary to edit the high setpoint so it is higher than 1.0. The Wrist Display has user programmable low and high setpoints. The default low setpoint is 0.7 ata  $O_2$ . The default range for low or high setpoints are 0.5 – 1.4. The PRISM 2 Displays and Electronics User Manual contains full details on how to program setpoints.

### Adjusting high setpoint (2 steps)

- Step 1: Menu to dive setup

Depress the menu (left) button until you come to the “dive setup” screen (*Fig. 2.119*).

- Step 2: Menu to edit high setpoint high setpoint: \_\_\_\_\_ Press the select button (right) to enter the “edit high SP” screen (*Fig. 2.120*). Press the select button again to edit the low setpoint value. Pressing the menu button will change the value incrementally and continue to roll over until a value is saved using the select button.

### B: Solenoid fires & oxygen injection is verified

This step will check that the solenoid is adding oxygen to the breathing loop when it fires. As long as the high setpoint is greater than 1.0  $PO_2$ , the solenoid will begin firing to add oxygen to the loop. If the high setpoint is less than 1.0  $PO_2$ , you will either need to drop the loop  $PO_2$  by injecting diluent via the ADV or increase the high setpoint in the System Setup menu. Once the solenoid begins injecting  $O_2$ , you should be able to hear the oxygen entering the loop at the head plate, but if you are in a noisy environment, such as on a boat, you can simply turn off the  $O_2$  cylinder valve momentarily and watch for the pressure gauge needle to drop as the solenoid fires or release some pressure from the loop by manually pressing the OPV, then watch as the counterlungs expand as the  $O_2$  enters the loop. Make sure to turn the oxygen valve back on if you momentarily shut the valve during the test. If the solenoid fires but no oxygen is injected, check to see if the 0.0020ths in-line restrictor located in the hose fitting at the first stage (*Fig. 2.121*) could be clogged. Do not dive without this restrictor in place.

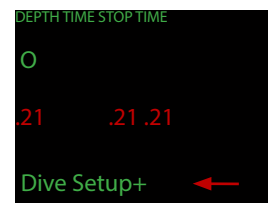

Fig. 2.119

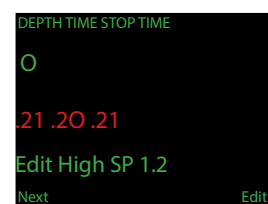

Fig. 2.120



Fig. 2.121

**C: Change setpoint to .19** Once the solenoid has fired and you have verified that oxygen is getting into the loop, change the active setpoint back to .19 by depressing the menu button 8 times until “Setpoint .19” shows on screen (Fig. 2.122). Depress the select button once. The solenoid should stop firing.

**D: Solenoid and wrist display battery check**

From the main screen depress the select (right) button eight times until the EXT V (external [solenoid] voltage) and INT V (internal [wrist display] voltage) readings are displayed on the bottom of the screen (Fig. 2.123). Record the EXT V in the space provided. A voltage greater than 7 V is considered acceptable and below 7 V indicates the alkaline batteries must be replaced before diving. Do not use a voltage meter to check battery state as most meters do not put a load on the battery and will give artificially high readings as a result.

On the same display screen as the solenoid battery (EXT V) is the battery voltage for the Wrist Display battery shown under “INT V” (Fig. 2.124). Check and record the “INT V” value in the space provided. If the voltage value is flashing yellow or red, you must replace the battery before diving.



Fig. 2.122



Fig. 2.123

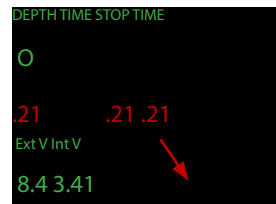

Fig. 2.124



**NOTE:** The voltage screen is timed and will automatically go back to the main screen after 20 seconds. To make your life easier, it would be a good idea to record both battery voltages at the same time.

**11. INSTALL COVER**

Attach the PRISM 2 cover to the back of the unit to protect the scrubber head.

**12. DILUENT SYSTEM LEAK TEST**

This test will determine if there are any leaks in the diluent system.

**A: Open diluent cylinder**

Slowly open the diluent cylinder valve. Allow the hoses to fully stretch and pressurize. With new hoses, allow them to stretch for a minute or two while the cylinder is on. Shut off the diluent cylinder valve.

**B: Watch diluent pressure gauge for pressure loss**

Watch the diluent pressure gauge for at least a minute, looking for any pressure drop. If the diluent first stage and hoses are slowly losing pressure you can use a spray bottle filled with soapy water to track down the leak. Never dive the PRISM 2 with leaks in the diluent system as catastrophic loss of pressure could occur during a dive.



**NEVER DIVE A PRISM 2 WHICH CANNOT PASS A DILUENT OR O<sub>2</sub> LEAK TEST. LEAKS NEVER GET BETTER UNDERWATER! DIVING WITH LEAKING PNEUMATIC SYSTEMS MAKE YOU LOOK SILLY AND WORSE, CAN LEAD TO INJURY OR DEATH.**



**C: Open diluent cylinder**

Open the diluent cylinder valve.

**13. CHECK ADV AND BCD****A: Open DSV (CC mode), inhale from the loop until ADV engages, dropping loop PO<sub>2</sub>.**

Open DSV inhale through your mouth, and exhale through your nose, until the inhalation lung collapses fully. When collapsed the ADV should actuate to add gas into the loop.

**B: BCD inflation + deflation mechanisms air holding**

Auto-inflate the buoyancy compensator partially and verify that it is holding pressure. Deflate the buoyancy compensator by letting a little air out of each deflation mechanisms.

**14. PRE-BREATHE**

**WARNING: DESPITE DOING A PRE-BREATHE, IT IS ENTIRELY POSSIBLE THAT UNHEALTHY LEVELS OF CO<sub>2</sub> CAN BUILD UP IN THE BREATHING LOOP FOR ANY NUMBER OF SEEN AND UNFORESEEN REASONS. YOU MUST REMAIN VIGILANT FOR THE SYMPTOMS OF CO<sub>2</sub> POISONING AT ALL TIMES WHILE DIVING ! A REBREATHER.**

**A. Change wrist display to low setpoint**

The active setpoint is presently .19 which was set in step 3. Depress the menu button 3 times until “Switch .19 > xx” is displayed on the screen. Depress the select button once to select the programmed low setpoint.

**B. Block nose and begin breathing from the PRISM 2 (in a safe location)**

Prebreathing gives you time to verify that all systems are go prior to entering the water. It is unlikely that even a 5 minute pre-breathe can identify a problem with the absorbent, or even verify that you have installed the absorbent basket in the loop! So don't allow a pre-breathe regimen to lull you into a false sense of security. Remain vigilant, especially during the first few minutes of a dive, for any signs or symptoms of CO<sub>2</sub> buildup, and bailout to OC at the first hint of trouble.

### C. Observe setpoint maintenance

Once you have metabolized enough loop O<sub>2</sub> that the electronics register the drop in O<sub>2</sub> and fire the solenoid, watch how the O<sub>2</sub> sensors react. They should not register a large jump in PO<sub>2</sub> but an incremental increase over 3 or 4 breaths back to the active setpoint.



**IF YOU SEE ERRATIC PO<sub>2</sub> READINGS OR WILD SWING IN PO<sub>2</sub>, DO NOT DIVE THE REBREATHER, AS THAT WOULD INDICATE A SERIOUS PROBLEM WITH THE ELECTRONICS, SENSORS OR WIRING THAT COULD LEAD TO POSSIBLE INJURY OR DEATH.**

**If diving immediately, continue with Immediate Pre-Dive Checks now.**

**If NOT diving immediately: Close O<sub>2</sub> and diluent cylinder valves & drain lines, turn off electronics and secure unit.**

## PRE-DIVE CHECKS:

### 15. WEIGHTS

After some trial and error you will figure out how much weight you will need to safely dive the PRISM 2. How you choose to distribute that weight is mostly a comfort issue, based on your physical build. The PRISM 2 has weight pockets sewn into the back of each counterlung. The only hard and fast rule regarding weight distribution is that the majority of the weight must be easily ditch-able in the event of a catastrophic loop flood on the surface or any event requiring an emergency buoyant ascent from depth.

#### A: Counterlung

Each front mounted counterlung can hold up to 5 lbs/2.2 kg of either hard or soft lead. How much lead you use is up to you, but most people report that 3 - 4 lbs/1.3 - 1.8 kg is sufficient to offset counterlung buoyancy. Some PRISM 2 divers prefer not to add weight to the counterlungs at all. Again, weight distribution is mostly a comfort and in-water trim issue. What works for one person may not work for another.

#### B: Trim weights

Depending on your system configuration, you may have various trim weights on the system. Since trim weights are not easily ditch-able in an emergency, use them sparingly, and make sure that the total non-detachable weights, plus the weight of a fully flooded loop (17 lbs/7.7 kg) is not greater than the buoyancy compensator can lift and maintain positive buoyancy on the surface.

## 16. HUD AND WRIST DISPLAYS ON

**HUD** Turn on the HUD while watching the HUD LEDs. All LEDs on the HUD should begin to blink, reporting the O<sub>2</sub> content of the loop. (As a reminder, If the HUD displays orange for 30 seconds at start-up, you must change the battery before diving.

**Wrist Display** Turn on the wrist display by depressing both switches. Look at the Wrist Display and verify the content of the loop, that all three O<sub>2</sub> sensors readings agree, the battery is charged and the setpoint is set correctly for the dive.

## 17. CYLINDER VALVES OPEN

Ensure O<sub>2</sub>, diluent, bailout, and any offboard drysuit inflation cylinders are open.

## 18. VERIFY SETPOINT AND LOOP CONTENTS

### A: Verify active setpoint on “low setpoint” ( $\geq 0.4$ )

Make sure your PO<sub>2</sub> is on a breathable setpoint, **NOT** 0.19.

### B: Verify loop contents are within user set limits on wrist display

You should not attempt to breathe from the loop if the Wrist Display indicates the O content in the loop is less than your preset low setpoint.



**WARNING: ALWAYS VERIFY THAT YOUR GAS SUPPLY CYLINDERS ARE TURNED ON PRIOR TO ENTERING THE WATER! HAVE YOU EVER JUMPED IN THE WATER WHILE DIVING AN OPEN CIRCUIT SYSTEM ONLY TO FIND OUT YOU FORGOT TO TURN YOUR AIR ON? IT'S A PRETTY OBVIOUS OVERSIGHT THE MOMENT YOU TRY TO INHALE GAS. IF YOU DO THAT ON A CLOSED CIRCUIT RIG WITH YOUR O<sub>2</sub> CYLINDER, THE CONSEQUENCES MAY BE DELAYED (YOU CAN STILL BREATHE ON THE LOOP) BUT MAY BE FATAL.**

At this point in the set-up, the computer should be monitoring the O<sub>2</sub> content of the loop and adding O<sub>2</sub> to keep the loop at your user selected low setpoint. If the loop PO<sub>2</sub> is low, check that you have not accidentally switched from low setpoint to the 0.19 PO<sub>2</sub> setting in the computer.

**Do not** dive your PRISM 2 until you verify the computer is maintaining your programmed loop PO<sub>2</sub>.

## 19. DON THE PRISM 2

Attach counterlung straps, crotch strap(s), cummerbund and waist strap, and tighten as needed.

## 20. PRE-JUMP

### A: Begin Breathing Unit

Pre-breathing gives you time to verify that all systems are go prior to entering the water. It is unlikely that even a 5 minute pre-breathe can identify a problem with the absorbent, or even verify that you have installed the absorbent basket in the loop! So don't allow a pre-breathe regimen to lull you into a false sense of security. Remain vigilant, especially during the first few minutes of a dive, for any signs or symptoms of CO<sub>2</sub> buildup, and bailout to OC at the first hint of trouble.

To do a proper pre-breathe, block your nose by pinching it and remain securely seated throughout the pre-breathe while constantly monitoring and maintaining a safe loop PO<sub>2</sub>.



**WARNING: DESPITE DOING A PRE-BREATHE, IT IS ENTIRELY POSSIBLE THAT UNHEALTHY LEVELS OF CO<sub>2</sub> CAN BUILD UP IN THE BREATHING LOOP FOR ANY NUMBER OF SEEN AND UNFORESEEN REASONS. YOU MUST REMAIN VIGILANT FOR THE SYMPTOMS OF CO<sub>2</sub> POISONING AT ALL TIMES WHILE DIVING A REBREATHER.**

### B: Check: ADV/ DSV, O<sub>2</sub> Add, Dil Add; BCD

Breathe the loop down (breathe in from mouth, exhale from nose) while watching the diluent SPG, until the diluent addition valve fires. The SPG needle should not move. If the needle moves it is likely that the Diluent cylinder valve is closed. Ensure that the valve is opened (counterclockwise) and retest.



**WARNING: THERE IS A DANGER OF INADVERTENTLY USING EXCESS GAS FROM BOTH DILUENT AND OXYGEN CYLINDERS WHEN USING AN ADV ON A BMCL IN CERTAIN ORIENTATIONS SUCH AS A HEADS DOWN OR A LEFT SHOULDER DOWN POSITION. WHEN USING THE BMCL WITH AN ADV EXTRA MONITORING OF CYLINDER CONTENTS GAUGES SHOULD TAKE PLACE.**

Now depress the ADV body until the valve fires. This will lower the loop  $PO_2$ . If the  $PO_2$  lowers enough below the setpoint, it will cause the electronics to fire the solenoid. Continue breathing from the loop. Return to Closed Circuit Mode.

Partially inflate the BCD and then check that all the deflation mechanisms of the BCD are operational and easily accessible.



**NOTE:** Save gas, manually inflate the BCD during setup when feasible!

### **C: Check SPG: $O_2$ , Dil (diluent); OC (open circuit bailout supplies)**

Momentarily depress the manual oxygen addition valve while watching the  $O_2$  SPG. You should hear (or feel) oxygen enter the loop and the SPG needle should not move. If the needle moves it is likely that the  $O_2$  cylinder valve is closed.

Ensure that the valve is opened (counterclockwise) and retest.

Check the pressure in each cylinder and verify that you have the planned amount of gas available in each cylinder. Breathe from all off-board bailout supplies to verify they work as well.

### **D. Observe setpoint maintained (within selected setpoint on HUD and Wrist Displays)**

Once you have metabolized enough loop  $O_2$  that the electronics register the drop below setpoint and fire the solenoid, watch how the  $O_2$  sensors react. They should not register a large jump in  $PO_2$  but an incremental increase over 3 or 4 breaths back to the active setpoint. If they do not react at all, or swing wildly between  $O_2$  readings, stop your pre-breathe immediately and recalibrate the sensors. Once re-calibrated, perform another Pre-Breathe. If your P2 still performs erratically with wild swings in  $PO_2$ , **DO NOT DIVE THE REBREATER**. It must then be evaluated and serviced by a qualified PRISM 2 Service Technician before any further use.

### **E. Always know $PO_2$**

Constantly monitor the breathing loop  $PO_2$  to ensure a safe breathing gas and proper function of your PRISM 2. Monitoring the  $PO_2$  is your best protection and early warning of a system or component failure.

*Don't forget to do your in-water bubble checks, and have a safe dive!*

## POST-DIVE CHECKLIST

Name:

Date: / /

**1. Verify and record batteries (Solenoid/Wrist Display).**

Solenoid battery: V: \_\_\_\_\_ Good  Replaced

Wrist Display battery: V: \_\_\_\_\_ Good  Replaced

**2. Turn off, Secure Wrist Display**

**3. Verify Heads Up Display Battery** Good  Replaced

**4. Drain counterlungs of fluid**

**5. Remove CL weights**

**6. Remove weight pockets, weights, rinse and hang to dry**

**7. Soak complete, sealed unit in fresh water for 20 minutes if possible or hose off with fresh water**

**8. Turn off O<sub>2</sub> and drain lines, remove cylinder**

**9. Turn off diluent and drain lines, remove cylinder**

**10. Detach Bucket from head, record absorbent usage, or discard absorbent material**

Stored for re-use

Discarded

Date packed: \_\_\_/\_\_\_/\_\_\_ Size: \_\_\_\_\_ Total hours used: \_\_\_\_\_

**11. Sanitize bucket**

**12. Inspect O<sub>2</sub> sensors, record readings in air**

Sensor 1: \_\_\_\_\_ Sensor 2: \_\_\_\_\_ Sensor 3: \_\_\_\_\_

**13. Disassemble mouthpiece to counterlung hose assembly, sanitize; hang to dry**

**14. Remove counterlungs, sanitize, hang to dry**

**15. Drain and hang BCD/backplate/head assembly in a shaded area to dry.**

**16. Review maintenance/repair log and address any repairs if required.**

## POST-DIVE CHECKLIST: DETAILS

During the post-dive tear-down, pay attention to each part looking for any damage or wear that would require maintenance or repair. Record the damage in your maintenance/repair log and address the needed repairs immediately after finishing your post-dive checklist.

### 1: VERIFY AND RECORD BATTERIES (SOLENOID/WRIST DISPLAY)

This is a good time to verify that the batteries in your PRISM 2 have enough power for continued use. Should you need to replace a battery, it is better to find out now than to be scrambling for new batteries during set-up.

Solenoid battery:            V: \_\_\_\_\_ Good             Replaced

Wrist Display battery:      V: \_\_\_\_\_ Good             Replaced

From the main menu, depress the select button (right) six times until the lower display shows the solenoid (ext) and Wrist Display (int) batteries. A voltage reading of less than 3.28 volts for the Wrist Display and a voltage of 4 volts for the solenoid indicate a battery that must be changed. If you change a battery, make sure to notate it on your maintenance log so you remember to replace the battery in your spares kit.

### 2: TURN OFF, SECURE WRIST DISPLAY

Turn off the Wrist Display. Secure the Wrist Display so it is not damaged during cleaning or tear-down. Pay particular attention to make sure the wiring is secured so you cannot snag it while moving the unit during cleaning and tear down.

### 3: VERIFY HEADS UP DISPLAY BATTERY

Turn off the Heads Up Display then turn it back on. If the display lights all LEDs continuously for 30 seconds upon turn-on, the battery must be replaced. Otherwise, consider the battery to be good, but have a spare in your kit just for safety. Remember, both the HUD and Wrist Displays prefer SAFT 3.6V AA lithium batteries (for longevity - 10hrs vs. 100+ hrs!) but can run on standard AA alkaline batteries in a pinch.



#### **4: DRAIN COUNTERLUNGS OF FLUID**

Your exhale counterlung will have fluid in it which contains both water from your dive environment (fresh or salt) and saliva and other “bio-lube”. Open the counterlung drain. A viscous fluid, either clear or slightly milky white will drain from the exhale lung.

The Inhale lung should have very little, if any fluid in it. If it does contain excessive fluid, that would indicate a leak somewhere on the inhale side of the loop. Do not dive the unit until you have found and repaired the leak.

#### **5: REMOVE COUNTERLUNG WEIGHTS**

Remove any weights you had in the counterlung weight pockets. Not having the additional weight in the counterlungs will make them easier to handle.

#### **6: REMOVE WEIGHT POCKETS, WEIGHTS, RINSE AND HANG TO DRY**

Remove weight pockets if supplied, or any other removable weights from the unit. Soak the pockets in fresh water then hang to dry.

#### **7: SOAK COMPLETE, SEALED UNIT IN FRESH WATER FOR 20 MINUTES IF POSSIBLE OR HOSE OFF WITH FRESH WATER**

Submerge the rebreather in a fresh water rinse tank if one is available. Put the unit in the water and drain all the air from the counterlungs by holding the mouth-piece above water and opening it to let the gas escape from the loop. Also, drain all gas from the buoyancy system. Allow the unit to soak for 20 minutes.

If a rinse tank is not available, rinse the unit as best as you can with a hose. Pay special attention to the core of the system (head, bucket, bladder, first stages, and hoses). Any items that will be removed for sanitizing in the following steps can be soaked separately in a bucket or other small container.



**NOTE:** *Why Sanitize Your Loop Daily?*

A rebreather “loop” collects all sorts of biological material during a dive. There is your saliva, which fortunately is composed of 98% water. However the other 2% consists of compounds such as electrolytes, mucous, blood and various enzymes that normally begin the process of breaking down food, and most likely food particulates from a recently eaten meal or snack. Then you add in seawater (if you are diving in the ocean or freshwater, both of which contain living and dead microscopic creatures. Now, imagine allowing this solution to sit and putrefy for a few days in a dank, dark hole, all the while collecting more and more dead and dying biomass while you continue diving. Would you knowingly want to breathe from this? I didn’t think so. Make it your habit to sanitize your breathing loop after each dive day and you will never have to think about this again.

**8: TURN OFF O<sub>2</sub> AND DRAIN LINES, REMOVE CYLINDER**

Turn off the O<sub>2</sub> cylinder valve. Depress the manual O<sub>2</sub> addition valve until the first stage and hoses are fully drained. Unscrew the O<sub>2</sub> first stage, loosen the cylinder straps, remove the cylinder. Put the dust cover on the first stages.

**9: TURN OFF DILUENT AND DRAIN LINES, REMOVE CYLINDER**

Turn off the diluent cylinder valve. Depress the ADV until the diluent first stage and hoses are fully drained. The diluent first stage, loosen the cylinder straps, remove the cylinder. Make sure to put the cover on the first stage fitting.

**10: DETACH BUCKET FROM HEAD, RECORD ABSORBENT USAGE OR DISCARD ABSORBENT MATERIAL**

Stored for re-use  Discarded

Date packed: \_\_\_/\_\_\_/\_\_\_ Size: \_\_\_\_\_ Total hours used: \_\_\_\_\_

It is extremely important that any absorbent that is not immediately thrown out is stored shortly after removal in an airtight container. This will insure that the moisture in the absorbent pellets necessary to maintain the chemical reactions that scrub CO<sub>2</sub> does not evaporate.

It is also extremely important that you track the usage of the absorbent pack so you do not accidentally over-use the absorbent pack beyond its serviceable life. Never use absorbent beyond its serviceable life. Using absorbent beyond its serviceable life can lead to injury or death. If you are ever in doubt, throw out the absorbent and re-pack with fresh material. Your life is worth far more than the cost of 6 lbs/2.7 kg of absorbent.

## 11: SANITIZE BUCKET

If you are using Steramine™ or other dissolving sanitizers, the scrubber bucket is a great vessel to mix up 1 gallon / 3.78 L of sanitizer and soak the breathing hoses, DSV and moisture pad, then pour the remaining sanitizer into the counterlungs to sanitize them.

For 1 gallon / 3.78 L, fill the bucket to 3/4 inch/19 mm below the bottom of the stainless steel latch strap.

After using the sanitizer, either dry the bucket with a clean, dry towel or turn the bucket over and allow it to drip-dry.



NOTE: Hey, Sanitizer junkies... MORE IS NOT BETTER! Using more than 1 or 2 Steramine tablet per gallon DOES NOT increase the bacteria killing efficacy of the sanitizer. It does however leave a nice sticky, blue pollen of dried sanitizer on everything it has touched. 1 or 2 tablets per gallon means 1 OR 2 TABLETS PER GALLON!

## 12: INSPECT O<sub>2</sub> SENSORS, RECORD READINGS IN AIR

Sensor 1: \_\_\_\_\_ Sensor 2: \_\_\_\_\_ Sensor 3: \_\_\_\_\_

After settling in air for a few moments, each O<sub>2</sub> sensor should read 0.21 ata O<sub>2</sub>. Record the readings in either mV or PO<sub>2</sub>, whichever you feel is more relevant to your record keeping.

Acceptable millivolt range for a sensor in air is 8.5-14.5 mV.

# FMCL

## 13: DISASSEMBLE MOUTHPIECE TO COUNTERLUNG HOSE ASSEMBLY, SANITIZE, HANG TO DRY

Disassemble the FMCL DSV assembly, open the DSV shut-down valve and let soak in the sanitizer. Stretch each hose and allow excess fluid to drain out, then place the hoses in the sanitizer, making sure there are no air pockets trapped in the hose.

Remove the hoses and mouthpiece from the sanitizer and hang to dry.

## 14: REMOVE COUNTERLUNGS, SANITIZE, HANG TO DRY

Remove both counterlungs from the harness and drain any left over fluids by turning the lungs upside down and allowing the fluids to drip out of the hoses. Pour 1/2 of the sanitizer from the bucket into each counterlung, then slosh the liquid around inside the counterlung and hose. Drain the sanitizer and hang the lungs to dry.

### **15: DRAIN AND HANG BCD/BACKPLATE/HEAD ASSEMBLY IN SHADED AREA TO DRY**

Drain any water that might have collected in the buoyancy device then hang the unit core to dry somewhere away from direct sunlight and allow the fabric to dry.

### **16: FILL OUT MAINTENANCE/REPAIR LOG AND ADDRESS ANY REPAIRS IF REQUIRED**

Any items which you notated in your maintenance/repair log during the post-dive breakdown should be reviewed, and the parts in question re-examined closely and repaired or replaced as required. If parts are used from your spares kit, make note so that you can re-order replacements from your local Hollis PRISM 2 dealer.

# BMCL

### **13: DISASSEMBLE MOUTHPIECE TO COUNTERLUNG HOSE, SANITIZE, HANG TO DRY**

Remove the DSV from the loop and let soak in the sanitizer. Stretch each hose from each T-Piece and allow excess fluid to drain out.

### **14: REMOVE T-PIECES & GAS SUPPLY HOSES FROM T-PIECES.**

Remove the gas supply hoses from the T-Pieces (ADV supply hose, Diluent Addition Block, O<sub>2</sub> Addition Block). Remove the T-Pieces from the Counterlungs and soak the assembly in sanitizer. Hang to dry. In areas where there are a lot of bugs, moths and other flying/crawling critters, you may want to stretch some screen material (such as pantyhose or paper towels) over the counterlung opening and hold in place with a rubber band.



**CAUTION: DO NOT SOAK T-PIECES WITH THE MANUAL ADDITION BLOCKS STILL ATTACHED OR YOU WILL FLOOD THE BLOCKS WITH SANITIZER.**

### **15: SANITIZE COUNTERLUNGS, HANG TO DRY**

Remove the counterlungs from the rebreather and drain any left over fluids by turning the lungs upside down and allowing the fluids to drip out of the hoses. Pour 1/2 of the sanitizer from the bucket into the inhalation counterlung, then slosh the liquid around inside the counterlung. Drain the sanitizer back into the bucket. Now pour 1/2 of the sanitizer into the exhale counterlung and slosh the liquid around inside the counterlung. Holding the counterlung upright, pull on the counterlung drain and allow some sanitizer to run out. Turn the counterlung upside down and drain the sanitizer back into the bucket for further use or discard. Hang the counterlungs upside down and allow them to drip dry. In areas where there are a lot of bugs, moths and other flying/crawling critters, you may want to stretch some screen material (such as pantyhose or paper towels) over the counterlung opening and hold in place with a rubber band.

## **16: DRAIN AND HANG BCD/BACKPLATE/HEAD ASSEMBLY IN SHADED AREA TO DRY**

Drain any water that might have collected in the buoyancy device then hang the BCD, head and backplate to dry somewhere away from direct sunlight to dry. Every so often it is a good idea to sanitize the interior of the BCD before hanging it to dry. Do so, remove the Inflator hose and pour the remaining Steramine into the BCD bladder. Slosh it around then dump it out. Hang the BCD to dry with the hose removed. In areas where there are a lot of bugs, moths and other flying/crawling critters, you may want to stretch some screen material (such as pantyhose or paper towels) over the counterlung opening and hold in place with a rubber band.

## **17: FILL OUT MAINTENANCE/REPAIR LOG AND ADDRESS ANY REPAIRS IF REQUIRED**

Any items which you notated in your maintenance/repair log during the post-dive breakdown should be reviewed, and the parts in question re-examined closely and repaired or replaced as required. If parts are used from your spares kit, make note so that you can re-order replacements from your local Hollis PRISM 2 dealer.

# MAINTENANCE + REPAIR LOG

Owner: \_\_\_\_\_ Date of report: \_\_\_\_\_

Reason for maintenance (check one)

- Pre-Dive Failure
- Post-Dive Maintenance
- Preventative/Scheduled Maintenance

Part(s) Replaced \_\_\_\_\_

Reason \_\_\_\_\_  
\_\_\_\_\_  
\_\_\_\_\_

Parts needing service \_\_\_\_\_  
\_\_\_\_\_  
\_\_\_\_\_

Action \_\_\_\_\_  
\_\_\_\_\_  
\_\_\_\_\_

Operational observations \_\_\_\_\_  
\_\_\_\_\_  
\_\_\_\_\_

Replacement part(s) need to be ordered to complete this maintenance

Date Part(s) ordered: Expected delivery: \_\_\_\_\_

Signed: \_\_\_\_\_



# Hollis Prism 2 Rebreather Statement of Skill Competency & Course Completion Form

1. Working with PRISM 2 Checklists
2. Proper Dive Planning
3. Calibrate & Validation of oxygen sensors
4. Assembly and disassembly
5. Post Dive care, user service & maintenance requirements
6. Manufacturer resources & user software
7. Proper scrubber packing & limits
8. Evaluating system operations
9. Use and adjustment of computer controls
10. In-water bubble check
11. Controlled descents and ascents
12. Dropping weights & establishing positive buoyancy on the surface
13. DSV operation & use
14. Mask remove, replace & clearing
15. Neutral buoyancy
16. Minimum loop volume / OPV operation
17. Manual addition & control of diluent
18. Manual addition & control of oxygen
19. Clear water from hose
20. Completely Flooded Unit
21. CO<sub>2</sub> Breakthrough & Hypercapnia
22. High Oxygen - Hyperoxia
23. Low Oxygen - Hypoxia
24. Diving with off-board bailout
25. Off-board bailout assist of another diver
26. Emergency bailout with On-board and offboard gas supplies
27. Drop & Recover bailout cylinders while maintaining position in the water column
28. Decompression procedures
29. Maintain Safety/Decompression stop(s)
30. Oxygen Rebreather Mode
31. Valve shutdown
32. Gas hemorrhages and free-flowing regulator
33. Disconnecting & reconnecting quick disconnects
34. Changing computer setpoints underwater
35. Electronics & Battery failures
36. Computer settings for bailing-out
37. Rescue Skills & 50 m/150 ft Surface Diver Tow
38. Deploying an SMB/DSMB
39. Using a dry suit - where applicable to the dive environment

I fully understand the risk involved in diving the Prism 2 Rebreather and I know how to successfully complete all the above skills. I am competent in problem recognition and the appropriate resolution to all expected problems that may arise while diving and operating the Prism 2 Rebreather.

I have completed all academics, practical sessions and open water dives for the course. I have the competency to execute any and all the above skills during any dive that I may undertake in the future and will continue practicing these skills to ensure my continued competency on a regular basis.

Signature: \_\_\_\_\_ Date: \_\_\_\_\_

Name: \_\_\_\_\_

Hollis Document Control Number: XX-XXXX 02/16/2019

## MAINTENANCE + CLEANING SERVICE FACILITY & YOU

It is necessary to have a Hollis PRISM 2 Service Facility complete a “Full Service” annually to maintain safe operation of your PRISM 2. You may find some items that need attention before your scheduled annual service. Hollis has developed a “PRISM 2 User Service Guide” to aid you the user in completing many minor Maintenance tasks yourself. It is available for download at [www.Hollisrebreathers.com](http://www.Hollisrebreathers.com). **DO NOT** attempt to make any repairs without the guide.

Below is a list of items that require specialized training, tools, and techniques. If they need service before the scheduled annual service date, they must be repaired by a Hollis PRISM 2 Service Facility or the Hollis factory.

### SERVICE FACILITY ONLY PARTS

- Solenoid
- Solenoid Chamber Pressure Relief Valve
- Heads Up Display
- Wrist Display
- Heads Up Display Piezoelectric switch
- Electronics Compartment including printed circuit boards
- Oxygen first stage
- Oxygen Pressure gauge
- 2nd stage regulator
- Diluent first stage
- Diluent pressure gauge



**CAUTION: DO NOT attempt to unscrew the Heads Up Display wiring from the head or the Wrist Display wiring from either end of the wire. This is not a threaded part! Attempting to unscrew or remove either wiring will destroy the wiring and quite possibly the hardware sealing surface in the Head or Wrist Display.**



**CAUTION: Opening the electronics housing compartment or attempt to service Service Facility Only Parts by unauthorized persons will void the warranty.**



## ROUTINE CLEANING

### RED CO<sub>2</sub> SEAL

#### Tools Needed: None

If the gasket gets dirt or absorbent dust on it, remove the gasket from its groove and clean the surface of the gasket with warm, soapy water, rinse and allow to air dry. The gasket should feel “gummy” but not sticky to the touch. If the gasket has hardened or has cuts or abrasions on its surfaces it needs to be replaced. **DO NOT** use lubricant of any kind on the Red CO<sub>2</sub> Seal.

### O<sub>2</sub> SENSOR HOLDERS

#### Tools Needed: None

Each of the three O<sub>2</sub> sensor holders are held in place by 2 pins molded into the head assembly. They are made of a soft silicone. Remove the holders from their pins and clean with warm soapy water then rinse off and allow to air dry.

During annual service these will be checked to see if they are beginning to harden and will be replaced as necessary. **DO NOT** attempt to repair a torn cell holder.

### O<sub>2</sub> SENSOR HARNESS

#### Tools Needed: None

Use one drop of DeoxIT® Gold GN5 electrical contact cleaner on the contacts and wipe off any excess contact cleaner before re-installing the harness in the head. If the wiring, connectors are showing excessive oxidations, or the insulation is cracking, replace the harness.

### BREATHING HOSES

Tools needed: Oetiker clamp pliers, Large Bottle Brush, O-ring Lubricant Every ten hours of use you should scrub the inside of the counterlung hoses with a bottle brush and Steramine™ solution. First, remove the hose from the counterlung by removing the 2 Oetiker clamps holding it in place. This will insure that any debris scrubbed from the hose will not simply settle in the counterlung. Place the bottle brush inside the hose and place the hose in the bucket of Steramine™. Move the brush in and out of the hose to scrub the interior. Clean the hose attaching hardware as well. Finally, clean the attaching hardware O-ring, O-ring groove and treat it with approved lubricant.

## COUNTERLUNGS + DRAINS

**Tools Needed: Oetiker clamp pliers, large bottle brush, lubricant, Steramine™, clean dry cloth.**

You may choose to remove the breathing hose, or you can clean it as an assembly with the counterlung. Fill the counterlung with Steramine™ and thoroughly clean the inside with the bottle brush, being sure to scrub all sides, bottom and top.

Loosen the Counterlung drain locking collar and allow some Steramine™ to run through the drain hole. Pour the Steramine™ out of the counterlung and re-drain the counterlung drain.

If you removed the hose for cleaning, reattach the hose using the Oetiker clamps and hang the counterlung to dry. It is always recommended that if you hang the counterlungs to dry in an area where bugs can enter, you stuff all the holes in the counterlungs using paper towels. This will allow the interior of the lungs to dry while blocking bugs from getting in and making a home.

## DSV INHALATION HOSE + FITTINGS

**Tools Needed: Oetiker clamp pliers, large bottle brush, toothbrush, sponge, lubricant, Steramine™**

The inhalation side of the DSV hose assembly contains the inhalation side mushroom valve and valve seat. Before cleaning the hose, it is important to remove the mushroom valve and seat. Removing the part will allow you to run a bottle brush through the hose, but the valve and valve seat require special, separate treatment as described in the next section. To remove the valve seat, remove the 2 Oetiker clamps holding the valve seat and DSV counterweight, pull the part from the hose, and set it and the counterweight aside. Place the hose and elbow in a bucket of Steramine™ and run the bottle brush back and forth through the hose several times. Remove the hose and set it aside to dry.

The mushroom valve and valve seat are delicate parts and should be cleaned with care. Remove the O-ring on the outside edge of the valve body and set it aside. Using a soft sponge soaked with Steramine™, gently wipe down the topside of the mushroom valve and then gently lift the valve off the valve seat and wipe down the underside of the valve as well as the valve seat.

Clean the O-ring groove and set aside the valve body to dry. Clean the O-ring you had set aside, treat it with lubricant and reinstall it in its groove.

There is no need to sterilize the counterweight, but if you like keeping your gear shiny and looking new, you can soak it in water then wipe it down with a clean dry cloth to restore its shine.

Once the parts are dry, you can re-assemble the hose and fittings. Make sure that you put 2 clamps back in each hose fitting with the clamp openings 180 degrees opposed from each other.

Test the valve operation by attempting to gently inhale. You should see the mushroom valve firmly seat itself against the valve body but not be able to pull any air through. If the valve does not seal, the assembly must be replaced.

## **DSV EXHALATION HOSE + FITTINGS**

**Tools Needed: Oetiker clamp pliers, Large Bottle brush, toothbrush, lubricant, Steramine™**

Since there is no valve on the end of the hose assembly, you do not need to take the hose assembly apart for a simple cleaning. You can simply put the hose in a bucket filled with Steramine™ and clean the interior of the hose with a bottle brush. DO NOT attempt to force the bottle brush through the elbow fitting. Use the toothbrush to clean the fitting.

If you need to treat the O-ring under the counterweight, you will need to remove the 2 Oetiker clamps and pull the fitting from the hose. Put the counterweight aside. Remove the O-ring, clean and treat it and its mating groove, then replace the O-ring and reassemble the hose.

## **DSV (DIVE SURFACE VALVE)**

After a day of diving, the DSV can simply be soaked in Steramine™ solution and allowed to dry. Because the DSV barrel is opened and closed frequently and over time can become hard to actuate as the lubricant migrates away from the sealing Orings, it is always a good idea to service the valve during more thorough cleanings.

## **SCRUBBER BUCKET + BASKET SPRING**

The scrubber bucket does not need cleaning beyond rinsing with Steramine™ solution unless absorbent material builds up on the clear urethane. To clean built up absorbent material, wipe with white vinegar and rinse with fresh water.

The Stainless Steel band and 3 Nielson Sessions latches should remain free of rust as long as it is soaked in fresh water after use. There is no need to use any lubricants on the latches.

The scrubber basket-retaining piece and pressure spring are held on to the spring assembly-retaining stem with a stainless steel nylon locking nut and washer. The spring assembly-retaining stem is molded into the Urethane bucket. Neither part requires maintenance beyond normal cleaning with fresh water and checking that the locking nut is firmly in place.

## **SCRUBBER BASKET**

### **Tools Needed: White Vinegar, stiff toothbrush**

The scrubber basket requires cleaning after each use. Depending on the CO<sub>2</sub> absorbent used, the basket threads can become clogged with crushed absorbent, making screwing down the top difficult.

If absorbent dust does become caked in the threads, soaking the threads in white vinegar for 15 to 20 minutes will usually dissolve all the material. You may need to remove any residual material with a stiff toothbrush. After cleaning the basket, rinse it thoroughly with fresh water.

The center tube is removable in the event that it requires service or replacement. There is usually no need to remove the center tube. It is recommended that it is left in place whenever possible, except during annual service.

## BUOYANCY DEVICE

To keep your BCD, Wing, and/or Harness in top condition, follow these procedures, in sequence, after each day of diving:

- Fill the BCD one third full of fresh water through the inflator mouthpiece.
- Inflate fully, then rotate and shake, ensuring a complete internal rinse.
- Hold upside down and completely drain the water through the mouthpiece.
- Thoroughly rinse the outside of the BC with fresh water.
- Store partially inflated out of direct sunlight in a cool, dry place.
- Periodically flush the BCD with sanitizer solution (available in dive stores) or Steramine™ solution to kill any bacterial growth.
- Transport your BCD in a padded carrying case or equipment bag, separated from sharp items (e.g., dive knife, spear gun, etc.) that might puncture the bladder.
- You should also protect the inflation system from damage from heavy objects (e.g., dive light, weights, first stage, etc.).

## ALL OTHER EXTERNAL SURFACES

Though Hollis uses the best materials available, UV rays, salt water, and chlorine environments can be harsh on equipment. For that reason, it is essential to rinse all components with fresh water after use and avoid unnecessary UV exposures (DO NOT leave to dry or store equipment in sunlight). Following these recommendations will help keep your PRISM 2 looking like new.



**WARNING: NEVER ATTEMPT TO CLEAN YOUR REBREATHER, OR ANY PART OF YOUR REBREATHER IN A DISHWASHER OR ANY OTHER TYPE OF MACHINE THAT EMPLOYS HIGH PRESSURE JETS OF COLD, WARM OR SCALDING HOT WATER.**

# APPROVED PRODUCTS, CAPACITIES, & SPECS

## LIST OF APPROVED PRODUCTS FOR USE IN YOUR PRISM 2

### CO<sub>2</sub> SCRUBBER MATERIAL

The recommended material is Sofnolime® (8-12 mesh). Other brands have not been independently tested to evaluate performance or duration times. Use of other brands is at the sole discretion and responsibility of the user.

### BATTERIES

Solenoid - (2) 9 V alkaline or 9 V lithium

Wrist Display Ver. 1 - (1) AA SAFT LS 14500 lithium

Wrist Display Ver. 2 - (1) AA size (alkaline, lithium, or SAFT LS 14500)

Heads Up Display - (1) AA SAFT LS 14500 lithium

### CLEANING PRODUCTS



**WARNING: NEVER ATTEMPT TO CLEAN YOUR REBREATHER, OR ANY PART OF YOUR REBREATHER IN A DISHWASHER OR ANY OTHER TYPE OF MACHINE THAT EMPLOYS HIGH PRESSURE JETS OF COLD, WARM OR SCALDING HOT WATER.**

Steramine™ 1-G Tablet

White Vinegar

Crystal Simple Green® or Dawn™ (or similar mild) dish detergent

### MAINTENANCE PRODUCTS

CRISTO-LUBE® MCG 111

Tribolube 71®

DeoxIT® Gold GN5 Electrical Contact Cleaner

Other products not listed may be appropriate for use with the PRISM 2. If there is a particular product which you wish to use, please call the factory to make sure the product does not contain chemical components which may be harmful to components within the rebreather or the diver.



**CAUTIONS:** Consult manufacturer Material Safety Data Sheets for further safety recommendations for these materials.

Never use the following products or families of products on ANY part or surface of the PRISM 2 rebreather:

- Products which contain alcohol, high concentrations of chlorine, ammonia, gasoline, Benzene or any petrochemical-based solvent (Basically, any product with the suffix “ene” in it.)
- Polishes, wax, automotive cleaning products.
- Glues, binding agents, plastic fillers other than those specifically listed in the “maintenance and troubleshooting” or “approved products” sections of the manual.

## COMPONENT CAPACITIES + SPECS

### SCRUBBER DURATION (EN 14143 conforming testing)

- 190 min (0.5%, SEV CO<sub>2</sub>) using 8-12 @ 40 °F/4 °C, 1.6 L/min CO<sub>2</sub>, 131 fsw/40 msw
- 215 min (0.5%, SEV CO<sub>2</sub>) using 8-12 @ 40 °F/4 °C, 1.6 L/min CO<sub>2</sub>, 330 fsw/100 msw
- 190 min (0.5%, SEV CO<sub>2</sub>) using 8-12 @ 40 °F/4 °C, 3.0 L/min CO<sub>2</sub>, 18 fsw/6 msw

### TESTED OPERATIONAL RANGE OF THE PRISM 2

328 ft (100 m) of depth

water temperatures between 39° - 93° F (4° - 34° C)

### BUCKET CAPACITY

Total Capacity: 1.75 gallon / 6.6 Liter

(To measure 1 Gal / 3.8 Liters for mixing sterilizing agents in the field, fill bucket with fresh water to 3/4" (19mm) full, right at the bottom of the SS bucket latch strap.)

### COUNTERLUNGS

FMCL: 3.5 L Inhalation & 3.5 L Exhalation (Optional 2.5 L currently available in the USA market only)

BMCL: (housed): 3.5L Inhalation, 3.5L Exhalation

### CYLINDERS (Sold separately at Hollis Rebreather dealers)

On-Board gas cylinder carrying capacity:

Two 3-liter Steel Cylinders (one oxygen, one diluent) with 232 bar maximum allowed pressure and compliant with the Pressure equipment directive (PED) and recognized standards.

Diluent 3 Liter Faber cylinder - Part number #AP6H

Oxygen 3 Liter Faber cylinder - Part number #AP6HOC

### VALVES (sold separately at Hollis Rebreather dealers)

Oxygen Valve: Green Hand Knob, M26x2 connection, EN144-3 - Part number #RB13A/G

Diluent Valve: Black Hand Knob, 5/8 BSP connection, ISO 12209 - Part number #RB13

### DILUENT CYLINDER GASES

Air - a maximum depth of 40 m

Trimix 9/60 (9% oxygen/60% helium) - a maximum depth of 100 m

Diluent duration depends on the depth and activity of the diver

### OXYGEN CYLINDER GAS

Oxygen supply is expected to last approximately 280 minutes, if the diver consumes 1.6 liters of oxygen per minute. (3 liter x 200 bar = 600 liter - 25% reserve = 450 liters, 450 l/1.6 l/min = 281 mins.)

### BREATHING HOSES

FMCL: 1 1/2" X 14" (3.8cm x 35.56cm) Head to Counterlung & Counterlung to Mouthpiece

BMCL: 1 1/2" x 11" (3.81cm x 27.94cm) Head to T-Piece & 1 1/2" x 16" (3.81cm x 40.64cm) T-Piece to Mouthpiece

### OXYGEN SENSORS

Hollis Prism 2

Analytical Industries PSR-11-39-MD

Storage Temperature Range: 32 °F/0 °C - 122 °F/50 °C

Operational Voltages: Air: 8.5-14 mV, 100%O<sub>2</sub>: 40.6-67 mV

## GLOSSARY

**Absorbent:** chemical media used to remove CO<sub>2</sub> from exhaled gas ADV: automatic diluent valve

**Bailout:** redundant gas supply system

**Breakthrough:** where absorbent scrubber fails, no longer removing CO<sub>2</sub> at an adequate rate

**Breathing Loop:** parts of the rebreather that breathing gas circulates within

**Caustic Cocktail:** very alkaline liquid (water mixed with CO<sub>2</sub> absorbent material)

**CCR (CC):** closed circuit rebreather

**Diluent:** a gas used for breathing volume and to reduce the fraction of oxygen in the Breathing Loop

**DSV:** dive surface valve

**FO<sub>2</sub>:** fraction of oxygen

**HP:** high pressure

**IP:** intermediate pressure

**LP:** low pressure

**Negative Pressure Check:** a test placing the Breathing Loop under a vacuum condition to check for leaks

**OC:** open circuit

**OPV:** over-pressure valve

**PO<sub>2</sub>:** partial pressure of oxygen

**Positive Pressure Check:** a test that looks for leaks in the Breathing Loop when pressurized

**QD:** quick disconnect

**WOB:** work of breathing



## NOTES

---

---

---

---

---

---

---

---

---

---

---

---

---

---

---

---

---

---

---

---

---

---

---